

# ONKYO®

## AV Receiver

# TX-DS494

## Instruction Manual

Thank you for purchasing the Onkyo AV Receiver. Please read this manual thoroughly before making connections and plugging in the unit. Following the instructions in this manual will enable you to obtain optimum performance and listening enjoyment from your new AV Receiver. Please retain this manual for future reference.

## Contents

### Before using

Important Safeguards .....	2
Precautions .....	3
Features .....	4
Supplied accessories .....	4
Before using this unit .....	5

### Facilities and connections

Front panel facilities .....	6
Remote controller .....	9
Rear panel facilities .....	10
Example of how to connect your equipment .	12
Positioning speakers .....	16
Connecting speakers .....	17
Connecting antennas .....	18
Connecting the power .....	20

### Enjoying music or videos

Speaker Setup .....	21
Selecting a sound source .....	22
Listening to Radio Broadcasts .....	24
To enjoy Surround mode .....	26
Recording a source .....	29

### Remote controller

Using remote controller .....	30
Pre-programming remote controller (North American models only) .....	32

### Appendix

Troubleshooting guide .....	34
Specifications .....	back cover page

## WARNING:

TO REDUCE THE RISK OF FIRE OR ELECTRIC SHOCK, DO NOT EXPOSE THIS APPLIANCE TO RAIN OR MOISTURE.

## CAUTION:

TO REDUCE THE RISK OF ELECTRIC SHOCK, DO NOT REMOVE COVER (OR BACK). NO USER-SERVICEABLE PARTS INSIDE. REFER SERVICING TO QUALIFIED SERVICE PERSONNEL.



**WARNING**  
RISK OF ELECTRIC SHOCK  
DO NOT OPEN

**AVIS**  
RISQUE DE CHOC ELECTRIQUE  
NE PAS OUVRIR



The lightning flash with arrowhead symbol, within an equilateral triangle, is intended to alert the user to the presence of uninsulated "dangerous voltage" within the product's enclosure that may be of sufficient magnitude to constitute a risk of electric shock to persons.



The exclamation point within an equilateral triangle is intended to alert the user to the presence of important operating and maintenance (servicing) instructions in the literature accompanying the appliance.

# Important Safeguards

- 1. Read Instructions** – All the safety and operating instructions should be read before the appliance is operated.
- 2. Retain Instructions** – The safety and operating instructions should be retained for future reference.
- 3. Heed Warnings** – All warnings on the appliance and in the operating instructions should be adhered to.
- 4. Follow Instructions** – All operating and use instructions should be followed.
- 5. Cleaning** – Unplug the appliance from the wall outlet before cleaning. The appliance should be cleaned only as recommended by the manufacturer.
- 6. Attachments** – Do not use attachments not recommended by the appliance manufacturer as they may cause hazards.
- 7. Water and Moisture** – Do not use the appliance near water –for example, near a bath tub, wash bowl, kitchen sink, or laundry tub; in a wet basement; or near a swimming pool; and the like.
- 8. Accessories** – Do not place the appliance on an unstable cart, stand, tripod, bracket, or table. The appliance may fall, causing serious injury to a child or adult, and serious damage to the appliance. Use only with a cart, stand, tripod, bracket, or table recommended by the manufacturer, or sold with the appliance. Any mounting of the appliance should follow the manufacturer's instructions, and should use a mounting accessory recommended by the manufacturer.
- 9. An appliance and cart combination** should be moved with care. Quick stops, excessive force, and uneven surfaces may cause the appliance and cart combination to overturn.  

PORTABLE CART WARNING  
S3125A
- 10. Ventilation** – Slots and openings in the cabinet are provided for ventilation and to ensure reliable operation of the appliance and to protect it from overheating, and these openings must not be blocked or covered. The openings should never be blocked by placing the appliance on a bed, sofa, rug, or other similar surface. The appliance should not be placed in a built-in installation such as a bookcase or rack unless proper ventilation is provided. There should be free space of at least 20 cm (8 in.) and an opening behind the appliance.
- 11. Power Sources** – The appliance should be operated only from the type of power source indicated on the marking label. If you are not sure of the type of power supply to your home, consult your appliance dealer or local power company.
- 12. Grounding or Polarization** – The appliance may be equipped with a polarized alternating current line plug (a plug having one blade wider than the other). This plug will fit into the power outlet only one way. This is a safety feature. If you are unable to insert the plug fully into the outlet, try reversing the plug. If the plug should still fail to fit, contact your electrician to replace your obsolete outlet. Do not defeat the safety purpose of the polarized plug.
- 13. Power-Cord Protection** – Power-supply cords should be routed so that they are not likely to be walked on or pinched by items placed upon or against them, paying particular attention to cords at plugs, convenience receptacles, and the point where they exit from the appliance.
- 14. Outdoor Antenna Grounding** – If an outside antenna or cable system is connected to the appliance, be sure the antenna or cable system is grounded so as to provide some protection against voltage surges and built-up static charges. Article 810 of the National Electrical Code, ANSI/NFPA 70, provides information with regard to proper grounding of the mast and supporting structure, grounding of the lead-in wire to an antenna-discharge unit, size of grounding conductors, location of antenna-discharge unit, connection to grounding electrodes, and requirements for the grounding electrode. See Figure 1.
- 15. Lightning** – For added protection for the appliance during a lightning storm, or when it is left unattended and unused for long periods of time, unplug it from the wall outlet and disconnect the antenna or cable system. This will prevent damage to the appliance due to lightning and power-line surges.
- 16. Power Lines** – An outside antenna system should not be located in the vicinity of overhead power lines or other electric light or power circuits, or where it can fall into such power lines or circuits. When installing an outside antenna system, extreme care should be taken to keep from touching such power lines or circuits as contact with them might be fatal.
- 17. Overloading** – Do not overload wall outlets, extension cords, or integral convenience receptacles as this can result in a risk of fire or electric shock.
- 18. Object and Liquid Entry** – Never push objects of any kind into the appliance through openings as they may touch dangerous voltage points or short-out parts that could result in a fire or electric shock. Never spill liquid of any kind on the appliance.
- 19. Servicing** – Do not attempt to service the appliance yourself as opening or removing covers may expose you to dangerous voltage or other hazards. Refer all servicing to qualified service personnel.
- 20. Damage Requiring Service** – Unplug the appliance from the wall outlet and refer servicing to qualified service personnel under the following conditions:
  - When the power-supply cord or plug is damaged,
  - If liquid has been spilled, or objects have fallen into the appliance,
  - If the appliance has been exposed to rain or water,
  - If the appliance does not operate normally by following the operating instructions. Adjust only those controls that are covered by the operating instructions as an improper adjustment of other controls may result in damage and will often require extensive work by a qualified technician to restore the appliance to its normal operation,
  - If the appliance has been dropped or damaged in any way, and
  - When the appliance exhibits a distinct change in performance – this indicates a need for service.

21. **Replacement Parts** – When replacement parts are required, be sure the service technician has used replacement parts specified by the manufacturer or have the same characteristics as the original part. Unauthorized substitutions may result in fire, electric shock, or other hazards.
22. **Safety Check** – Upon completion of any service or repairs to the appliance, ask the service technician to perform safety checks to determine that the appliance is in proper operation condition.
23. **Wall or Ceiling Mounting** – The appliance should be mounted to a wall or ceiling only as recommended by the manufacturer.
24. **Heat** – The appliance should be situated away from heat sources such as radiators, heat registers, stoves, or other appliances (including amplifiers) that produce heat.

## Precautions

### 1. Warranty Claim

You can find the serial number on the rear panel of this unit. In case of warranty claim, please report this number.

### 2. Recording Copyright

Recording of copyrighted material for other than personal use is illegal without permission of the copyright holder.

### 3. AC Fuse

The fuse is located inside the chassis and is not user-serviceable. If power does not come on, contact your Onkyo authorized service station.

### 4. Care

From time to time you should wipe the front and rear panels and the cabinet with a soft cloth. For heavier dirt, dampen a soft cloth in a weak solution of mild detergent and water, wring it out dry, and wipe off the dirt. Following this, dry immediately with a clean cloth. Do not use rough material, thinners, alcohol or other chemical solvents or cloths since these could damage the finish or remove the panel lettering.

### 5. Power

#### WARNING

BEFORE PLUGGING IN THE UNIT FOR THE FIRST TIME, READ THE FOLLOWING SECTION CAREFULLY.

The voltage of the available power supply differs according to country or region. Be sure that the power supply voltage of the area where this unit will be used meets the required voltage (e.g., AC 230 V, 50 Hz or AC 120 V, 60 Hz) written on the rear panel.

Worldwide models are equipped with a voltage selector to conform to local power supplies. Be sure to set this switch to match the voltage of the power supply in your area before plugging in the unit.

#### For British models

Replacement and mounting of an AC plug on the power supply cord of this unit should be performed only by qualified service personnel.

#### IMPORTANT

The wires in the mains lead are coloured in accordance with the following code:

- Blue : Neutral
- Brown : Live

As the colours of the wires in the mains lead of this apparatus may not correspond with the coloured markings identifying the terminals in your plug, proceed as follows:

The wire which is coloured blue must be connected to the terminal which is marked with the letter N or coloured black.

The wire which is coloured brown must be connected to the terminal which is marked with the letter L or coloured red.

#### IMPORTANT

A 5 ampere fuse is fitted in this plug. Should the fuse need to be replaced, please ensure that the replacement fuse has a rating of 5 amperes and that it is approved by ASTA or BSI to BS1362. Check for the ASTA mark or the BSI mark on the body of the fuse.

IF THE FITTED MOULDED PLUG IS UNSUITABLE FOR THE SOCKET OUTLET IN YOUR HOME THEN THE FUSE SHOULD BE REMOVED AND THE PLUG CUT OFF AND DISPOSED OF SAFELY. THERE IS A DANGER OF SEVERE ELECTRICAL SHOCK IF THE CUT OFF PLUG IS INSERTED INTO ANY 13 AMPERE SOCKET.

If in any doubt, consult a qualified electrician.

FIGURE 1:  
EXAMPLE OF ANTENNA GROUNDING AS PER NATIONAL ELECTRICAL CODE, ANSI/NFPA 70

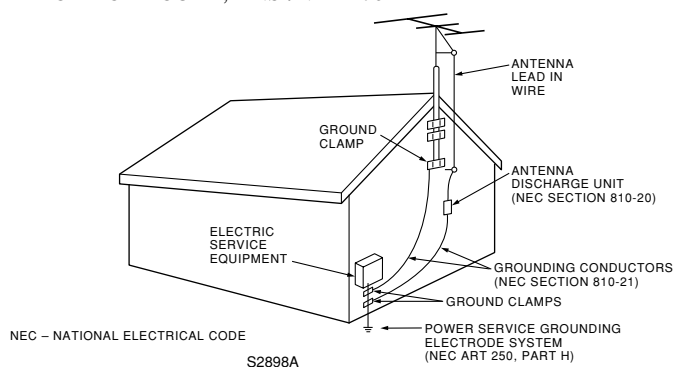

### For U.S. models

#### Note to CATV system installer:

This reminder is provided to call the CATV system installer's attention to Article 820-40 of the NEC, ANSI/NFPA 70, which provides guidelines for proper grounding and, in particular, specifies that the cable ground shall be connected to the grounding system of the building, as close to the point of cable entry as practical.

#### FCC Information for User

#### CAUTION:

The user changes or modifications not expressly approved by the party responsible for compliance could void the user's authority to operate the equipment.

#### NOTE:

This equipment has been tested and found to comply with the limits for a Class B digital device, pursuant to Part 15 of the FCC Rules. These limits are designed to provide reasonable protection against harmful interference in a residential installation. This equipment generates, uses and can radiate radio frequency energy and, if not installed and used in accordance with the instructions, may cause harmful interference to radio communications. However, there is no guarantee that interference will not occur in a particular installation. If this equipment does cause harmful interference to radio or television reception, which can be determined by turning the equipment off and on, the user is encouraged to try to correct the interference by one or more of the following measures:

- Reorient or relocate the receiving antenna.
- Increase the separation between the equipment and receiver.
- Connect the equipment into an outlet on a circuit different from that to which the receiver is connected.
- Consult the dealer or an experienced radio/TV technician for help.

#### For Canadian models

NOTE: THIS CLASS B DIGITAL APPARATUS COMPLIES WITH CANADIAN ICES-003.

For models having a power cord with a polarized plug:

**CAUTION:** TO PREVENT ELECTRIC SHOCK, MATCH WIDE BLADE OF PLUG TO WIDE SLOT, FULLY INSERT.

#### Modele pour les Canadien

REMARQUE: CET APPAREIL NUMÉRIQUE DE LA CLASSE B EST CON-FORME À LA NORME NMB-003 DU CANADA.

Sur les modèles dont la fiche est polarisée:

**ATTENTION:** POUR ÉVITER LES CHOCS ÉLECTRIQUES, INTRODUIRE LA LAME LA PLUS LARGE DE LA FICHE DANS LA BORNE CORRESPONDANTE DE LA PRISE ET POUSSER JUSQU'AU FOND.

# Features

## Amplifier Features

- 55 Watts minimum of continuous RMS power to each of the five channels into 8  $\Omega$  from 20 Hz to 20 kHz with no more than 0.08% THD (North American models, FTC rated)
- 75 Watts minimum of continuous RMS power to each of the five channels into 6  $\Omega$  at 1 kHz (European models, DIN)
- 100 Watts minimum to each of the five channels into 6  $\Omega$  at 1 kHz (Asian models, JEITA)
- Wide Range Amplifier Technology (WRAT)
- Extended Frequency Response (20 Hz to 100 kHz)
- Full bandwidth power to all 5 main channels
- High-current, low-impedance 6-Ohm drive for all five channels
- Oversized electrolytic capacitors
- State-of-the-art linear PCM 96 kHz/24-bit DACs for all channels
- Fully discrete output stages for all five channels
- Optimum Gain Volume Circuitry
- Massive isolated transformer
- 2 Large high-grade extruded-aluminum heat sinks
- A/B speaker drive
- Tone control (bass, treble) for front L/R speakers
- Auto-protection circuitry

## Audio/Video Features

- Dolby® Digital, DTS®\*, Dolby Pro Logic II decoding
- All Channel stereo
- 7 DSP soundfields
- High Definition DSP
- Late night mode (on, off)
- “Easy-set” speaker configuration
- Extensive bass management circuitry
- 5.1-Channel input
- Automatic signal detection
- 3 Assignable digital inputs (2 coaxial, 1 optical)
- 3 S-video inputs and 1 output
- 3 A/V inputs
- 3 Audio inputs
- Phono input
- Dedicated line-level subwoofer pre out
- Full input/output cassette and VCR loops
- 7 Sets of heavy-duty multiway speaker binding posts (dual banana-plug compatible)

## FM/AM Tuner Features

- Outstanding selectivity and sensitivity
- 30 FM/AM random presets
- FM auto tuning
- RDS (European models) with PS
- Red FM stereo indicator
- 75-Ohms antenna input
- FM indoor antenna supplied
- AM loop antenna supplied

## Other Performance Features

- Precision digital speed-sensitive volume control
- Absolute volume display
- Separate PC (printed circuit) boards for audio and video sources
- Large bright fluorescent display
- 2-Mode display dimmer (normal, dim)
- Individual input selectors for each source
- Headphone jack (standard size)
- Audio mute (remote controller)
- Sleep timer (remote controller)
- Battery-free memory backup
- 2 Switched AC convenience outlets with a total 120 watts max. (100 watts max. for European/Asian models)
- Heavy-duty power cord
- Large non-resonant feet
- Heavy-gauge, anti-resonant, reinforced-steel chassis
- Vibration-resistant cover
- Brushed aluminum front panel
- Powerful preprogrammed remote (North American models)

# Supplied accessories

Check that the following accessories are supplied with the TX-DS494.

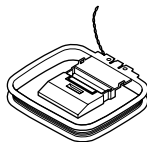

AM loop antenna × 1



FM indoor antenna × 1  
(Connector will vary depending on model specifications)

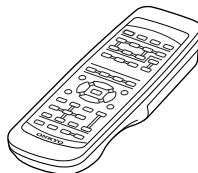

Remote controller × 1  
(RC-443S for models other than North American models, RC-444M for North American models)

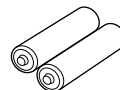

Batteries (AA, R6 or UM-3) × 2

The following accessories may be available depending on the area which it was purchased.

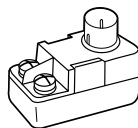

75/300  $\Omega$  antenna adapter × 1

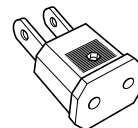

Conversion plug × 1

(Use this plug if the power cord plug of the TX-DS494 does not fit your AC outlet. Shape may vary depending on the area which it was purchased.)

## Declaration of Conformity

We, ONKYO EUROPE  
ELECTRONICS GmbH  
INDUSTRIESTRASSE 20  
82110 GERMERING,  
GERMANY



declare in own responsibility, that the ONKYO product described in this instruction manual is in compliance with the corresponding technical standards such as EN60065, EN55013, EN55020 and EN61000-3-2, -3-3

GERMERING, GERMANY

A handwritten signature in black ink.

A. HORIUCHI

ONKYO EUROPE ELECTRONICS GmbH

\* Manufactured under license from Dolby Laboratories. “Dolby”, “Pro Logic” and the double-D symbol are trademarks of Dolby Laboratories. Confidential Unpublished Works. ©1992-1997 Dolby Laboratories, Inc. All rights reserved.

\*\*Manufactured under license from Digital Theater Systems, Inc. US Pat. No.5,451,942 and other worldwide patents issues and pending. “DTS” and “DTS Digital Surround” are trademarks of Digital Theater Systems, Inc. ©1996 Digital Theater Systems, Inc. All rights reserved.

# Before using this unit

## Setting the AM tuning step frequency (Worldwide models only)

Worldwide models are equipped with a switch that controls the AM band tuning steps. Please set this switch to match the AM band tuning step frequency in your area.

U.S.A. and Canada: 10 kHz

Other areas: 9 kHz

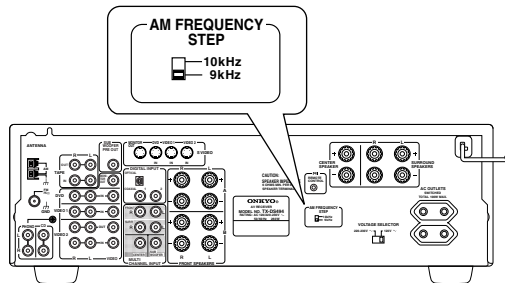

## Setting the voltage selector (Worldwide models only)

Worldwide models are equipped with a voltage selector to conform with local power supplies. Be sure to set this switch to match the voltage of the power supply in your area before plugging in the unit.

Determine the proper voltage for your area: 220-230 V or 120 V. If the preset voltage is not correct for your area, insert a screwdriver into the groove in the switch. Slide the switch all the way to the right (120 V) or to the left (220-230 V), whichever is appropriate.

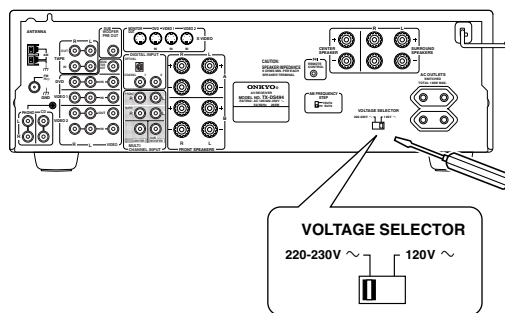

## Installing batteries into the remote controller

1. Remove the battery compartment cover by pressing and sliding the cover.

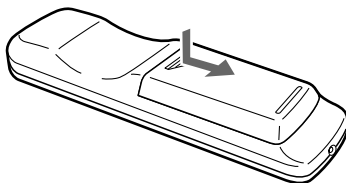

2. Insert two AA (R6 or UM-3) batteries into the battery compartment. Carefully follow the polarity diagram (positive (+) and negative (-) symbols) inside the battery compartment.

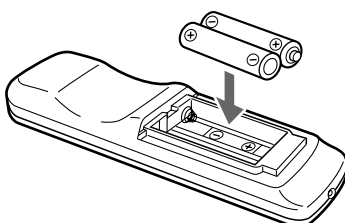

3. After batteries are installed and seated correctly, replace the compartment cover.

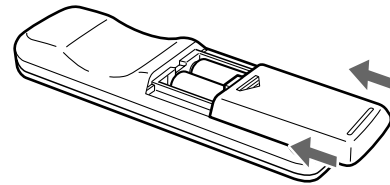

### Notes:

- Do not mix new batteries with old batteries or different kinds of batteries.
- To avoid corrosion, remove the batteries if the remote controller is not to be used for a long time.
- Remove dead batteries immediately to avoid damage from corrosion. If the remote controller does not operate smoothly, replace both batteries at the same time.
- The life of the batteries supplied is about six months but this will vary depending on usage.

## Using the remote controller

Point the remote controller toward the remote control sensor. The STANDBY indicator lights up when the unit receives a signal from the remote controller.

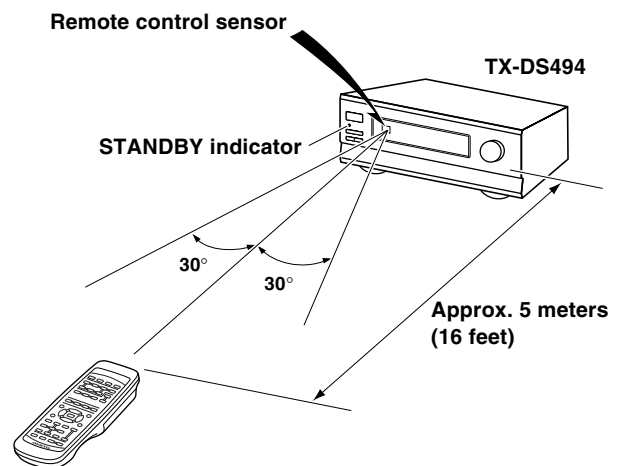

### Notes:

- Place the unit away from strong light such as direct sunlight or inverted fluorescent light which can prevent proper operation of the remote controller.
- Using another remote controller of the same type in the same room or using the unit near equipment which uses infrared rays may cause operational interference.
- Do not put objects on the remote controller. Its buttons may be pressed by mistake and drain the batteries.
- Make sure the audio rack doors do not have colored glass. Placing the unit behind such doors may prevent proper remote controller operation.
- If there is any obstacle between the remote controller and the remote control sensor, the remote controller will not operate.

# Front panel facilities

Here is an explanation of the controls and displays on the front panel of the TX-DS494.

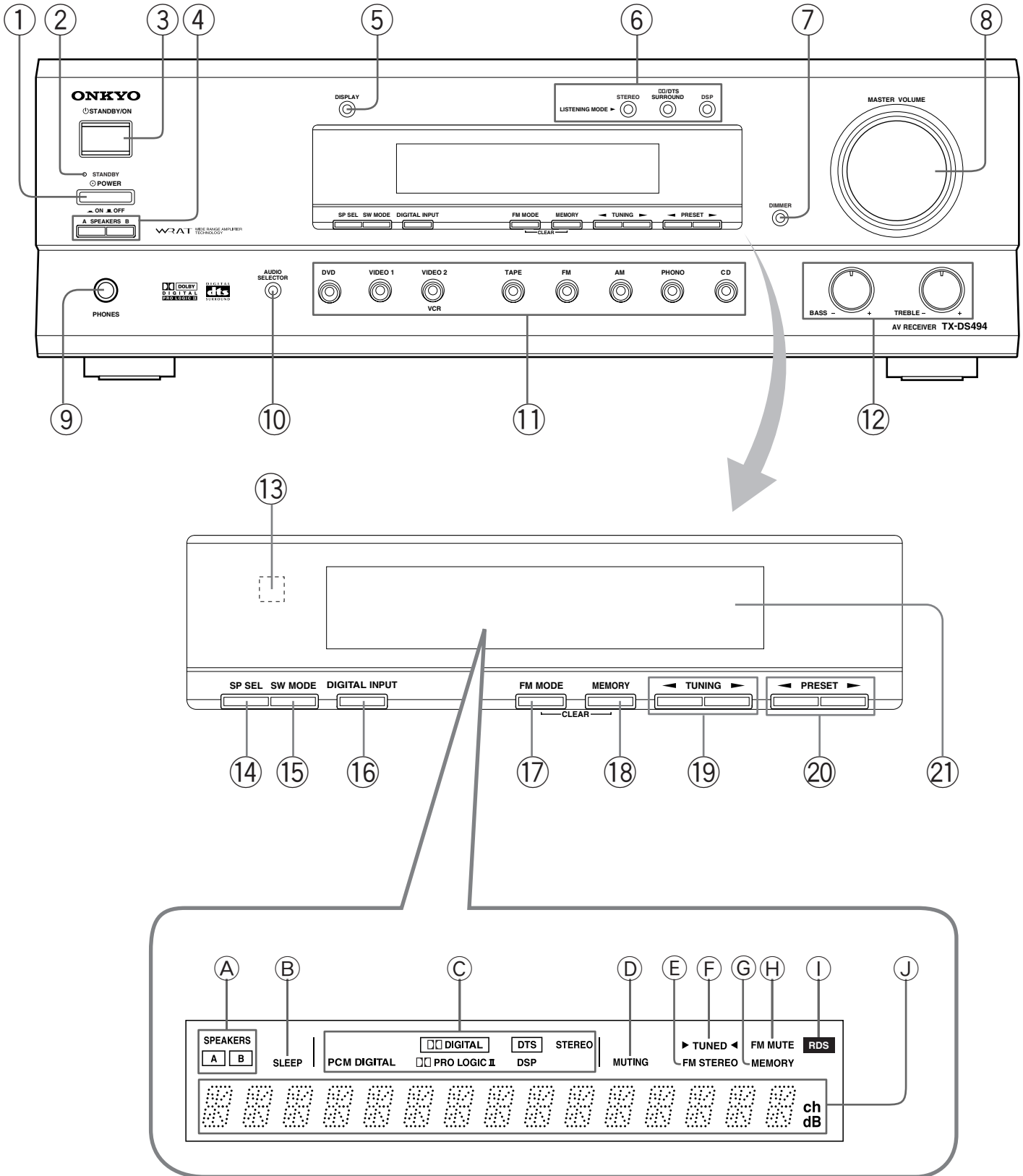

## Front panel facilities

### ① POWER switch

Turns on the main power supply for the TX-DS494. The TX-DS494 enters standby state and the STANDBY indicator lights up. Pressing the switch again to the off position (OFF) shuts down the main power supply into the TX-DS494.

- Before turning on the power, make sure all cables are properly connected.
- Turning on the TX-DS494 may cause a momentary power surge that might interfere with other electrical equipment on the same circuit. If this is a problem, plug the TX-DS494 into a different electrical circuit.

### ② STANDBY indicator

Lights when the TX-DS494 is in the standby state and flashes when a signal is received from the remote controller.

### ③ STANDBY/ON button

When STANDBY/ON button is pressed to ON while the POWER switch is set to ON, the display will light to show the current volume setting for about 5 seconds then show the current sound input source and listening mode. Pressing the button again returns the TX-DS494 to the standby state. This state turns off the display, disables control functions.

### ④ SPEAKERS A/B buttons

Press to switch the speaker systems in use between A and B.

**SPEAKERS A:** Select for the speakers connected to the FRONT SPEAKERS A, CENTER SPEAKER, SURROUND SPEAKERS and SUB WOOFER PRE OUT terminals. When the speakers are turned on, the SPEAKERS A indicator lights up.

**SPEAKERS B:** Select for the speakers connected to the FRONT SPEAKERS B terminals. When the speakers are turned on, the SPEAKERS B indicator lights up.

#### Notes:

- Be sure to use SPEAKERS A to listen to the sound through MULTI CHANNEL INPUT port or in any listening mode other than STEREO.
- You cannot select surround mode when you are using SPEAKERS B. If you select SPEAKERS B while surround mode is selected, surround mode will be automatically canceled.
- You cannot use the A and B speakers simultaneously.

### ⑤ DISPLAY button

Each time you press the DISPLAY button, the screen changes as follows:

#### When an input source other than FM or AM is selected:

Press the DISPLAY button once to initiate the program format display. Pressing the button again switches the display to the other display.

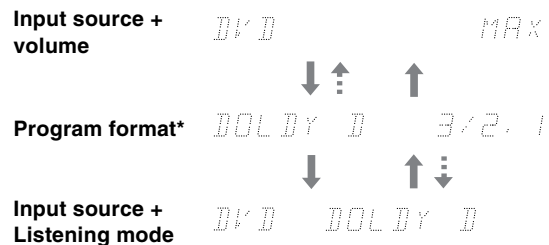

- \* If the input signal does not have a program format, then this will be skipped. The format display returns to the previous display after the format display has lasted for about 5 seconds (▶▶▶).

#### When FM or AM is selected as the input source:



#### When an RDS station broadcasting PS information is settled as the input source (European models only):

Press the DISPLAY button once to initiate the frequency display. Pressing the button again switches the display to the other display.

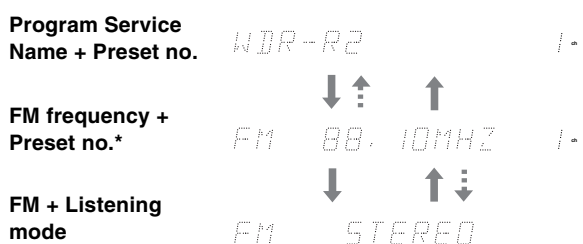

- \* The frequency display returns to the previous display after the frequency display has lasted for about 5 seconds (▶▶▶).

### ⑥ LISTENING MODE buttons

Press these buttons to select a listening mode for the current input source.

**STEREO:** Select for normal stereo output.

**□□/DTS SURROUND:** Select for the DOLBY PRO LOGIC II, DOLBY DIGITAL, or DTS surround modes.

**DSP:** Select for the ORCHESTRA, UNPLUGGED, or ALL CH ST surround modes. During Dolby Digital playback, this button is used to switch the Late Night function between ON and OFF.

## Front panel facilities

---

### ⑦ DIMMER button

Press to set the brightness of the front display. The brightness changes to normal and dim.

- The dimmer control for the front display can also be performed by using the remote controller.

### ⑧ MASTER VOLUME dial

The MASTER VOLUME dial is used to control the volume level. Turn the dial clockwise to increase the volume level and counterclockwise to decrease it.

### ⑨ PHONES jack

This is a standard stereo jack for connecting stereo headphones. The audio for the front right and left speakers are sent to the headphone speakers. When the headphones are plugged in, the listening mode automatically changes to STEREO and sounds are not output from the speakers.

### ⑩ AUDIO SELECTOR button

Press to select an audio input signal format other than FM, AM and PHONO. Each time this button is pressed, the setting cycles; “AUTO” → “MULTI CH” → “ANALOG” → “AUTO” (back to the beginning) (refer to page 23).

### ⑪ Input Selector Buttons (DVD, VIDEO 1, VIDEO 2, TAPE, FM, AM, PHONO, and CD)

These buttons are used to select the input source. Pressing and holding the TAPE button for about 2 seconds allows the TAPE and MD sources to be switched.

### ⑫ BASS and TREBLE control knobs

Boosts or cuts the bass and treble response.

**BASS:** Adjusts the bass response from the Front speakers and headphones. Turn the knob clockwise to boost the bass response. Turn the knob counterclockwise to cut the bass response.

**TREBLE:** Adjusts the treble response from the Front speakers and headphones. Turn the knob clockwise to boost the treble response. Turn the knob counterclockwise to cut the treble response.

### ⑬ Remote control sensor

This sensor receives the control signals from the remote controller.

### ⑭ SP SEL button

Press to select the optimum speaker configuration.

### ⑮ SW MODE button

Press to select the subwoofer mode.

### ⑯ DIGITAL INPUT button

When digital components are connected to the DIGITAL INPUT jacks of the TX-DS494, use this button to assign the DIGITAL INPUT jacks to them according to their forms of connection.

### ⑰ FM MODE button

Press to switch the reception mode between stereo and monaural. If audio is interrupted or noise interferes with audio during FM stereo broadcasting, press this button to switch to the monaural reception mode.

### ⑱ MEMORY button

This button is used to assign the radio station that is currently tuned in to a preset channel or delete a previously preset station.

### ⑲ TUNING ◀/▶ buttons

Use these buttons to change the tuner frequency. The tuner frequency is displayed in the front display and it can be changed in 50 kHz increments for FM and 10 kHz (or 9 kHz) increments for AM.

When FM is selected, you can hold down one of the TUNING ◀/▶ buttons and then release it to activate the auto-search feature. It will search for a station in the direction of the button you pressed and stop when it tunes into one.

### ⑳ PRESET ◀/▶ buttons

These buttons make it possible to store desired radio stations under the desired preset numbers and recall them with an easy operation.

### ㉑ Display

#### Ⓐ SPEAKERS A/B indicators

Shows the current speaker system in use.

#### Ⓑ SLEEP indicator

Lights up when the sleep timer is active.

#### Ⓒ Source/Listening mode indicators

One of these indicators lights to show the format of the current source as “PCM DIGITAL”, “□□ DIGITAL” or “DTS”. In addition, one of the listening mode indicators “□□ PRO LOGIC II”, “DSP” and “STEREO” lights according to the current listening mode.

#### Ⓓ MUTING indicator

Flashes when the mute function is active.

#### Ⓔ FM STEREO indicator

Lights up when an FM stereo broadcast station is received.

#### Ⓕ TUNED indicator

Lights up when a radio station is received.

#### Ⓖ MEMORY indicator

Lights up when the MEMORY button is pressed in the radio station preset operation.

#### Ⓗ FM MUTE indicator

Lights up to indicate FM muting. It extinguishes when the monaural reception mode is started by pressing the FM MODE button.

#### Ⓘ RDS indicator (European models only)

Lights up when a RDS station is received.

#### Ⓙ Multi function display

In usual operation, shows the current input source and volume. When the FM or AM input is selected, it shows the frequency and preset number. When the DISPLAY button is pressed, it shows the listening mode and input source format. However, it does not show the source format when the FM or AM source is selected.



# Remote controller

## RC-443S (For models other than North American models)

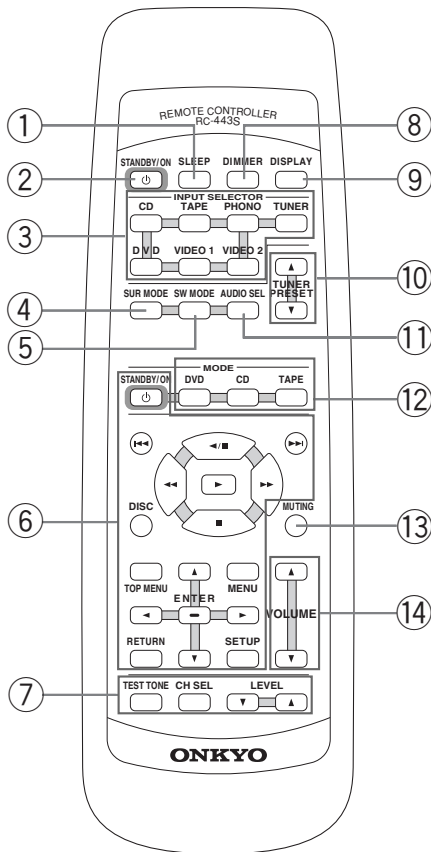

## RC-444M (For North American models)

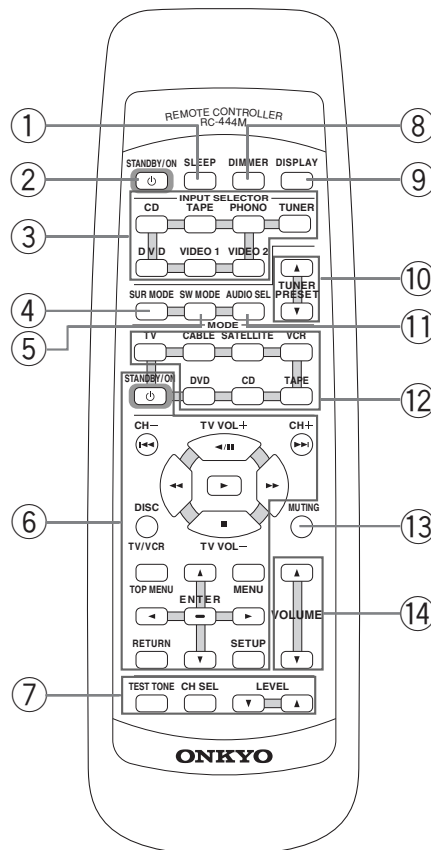

For detailed descriptions on the buttons, see “Front panel facilities” on pages 6 through 8.

### ① SLEEP button

For setting the sleep time.

This button is provided only on the remote controller (refer to page 23).

### ② STANDBY/ON button

Turns on the TX-DS494 or put it in standby.

### ③ INPUT SELECTOR buttons

For selecting the input source.

### ④ SUR MODE button

Press to select the surround mode.

### ⑤ SW MODE button

Press to select the subwoofer mode.

### ⑥ DVD/CD/TAPE operation buttons

For operating **RI**-connected Onkyo components connected to the TX-DS494.

When your remote controller is RC-444M, you can operate TV, VCR, satellite tuner and cable TV tuner from other brand than Onkyo by storing the pre-programming code.

For detailed descriptions on the buttons, see “Using remote controller” on page 30 and “Pre-programming remote controller (North American models only)” on page 32.

### ⑦ TEST TONE/CH SEL/LEVEL ▲/▼ buttons

For setting the output levels for each speaker.

These buttons are provided only on the remote controller (refer to page 21).

### ⑧ DIMMER button

For adjusting the brightness of the front display.

### ⑨ DISPLAY button

For changing the display.

### ⑩ TUNER PRESET ▲/▼ button

For selecting a tuner preset channel.

### ⑪ AUDIO SEL button

Press to select an audio input signal format other than FM, AM and PHONO.

### ⑫ MODE buttons

For selecting the component to be operated by the remote controller.

### ⑬ MUTING button

Activates the mute function.

This button is provided only on the remote controller (refer to page 23).

### ⑭ VOLUME ▲/▼ button

For adjusting the volume.

# Rear panel facilities

Here is an explanation of the terminals found on the rear of the TX-DS494 and how they are used. Before connecting your audio and video components, be sure to read this section carefully and then proceed to the explanations on how to connect each individual component (refer to page 12).

- Be sure to always refer to the instructions that came with the component that you are connecting.
- Do not plug in the power cord until all connections have been made.
- For input jacks, red connectors (marked R) are used for the right channel, white connectors (marked L) are used for the left channel, and yellow connectors (marked VIDEO) are used for video connections.

- Insert all plugs and connectors securely. Improper connections can result in noise, poor performance, or damage to the equipment.

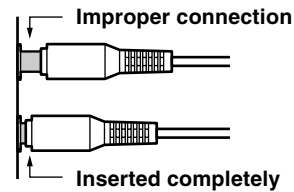

- Do not bind audio/video connection cables with power cords and speaker cables. Doing so may adversely effect the picture and sound quality.

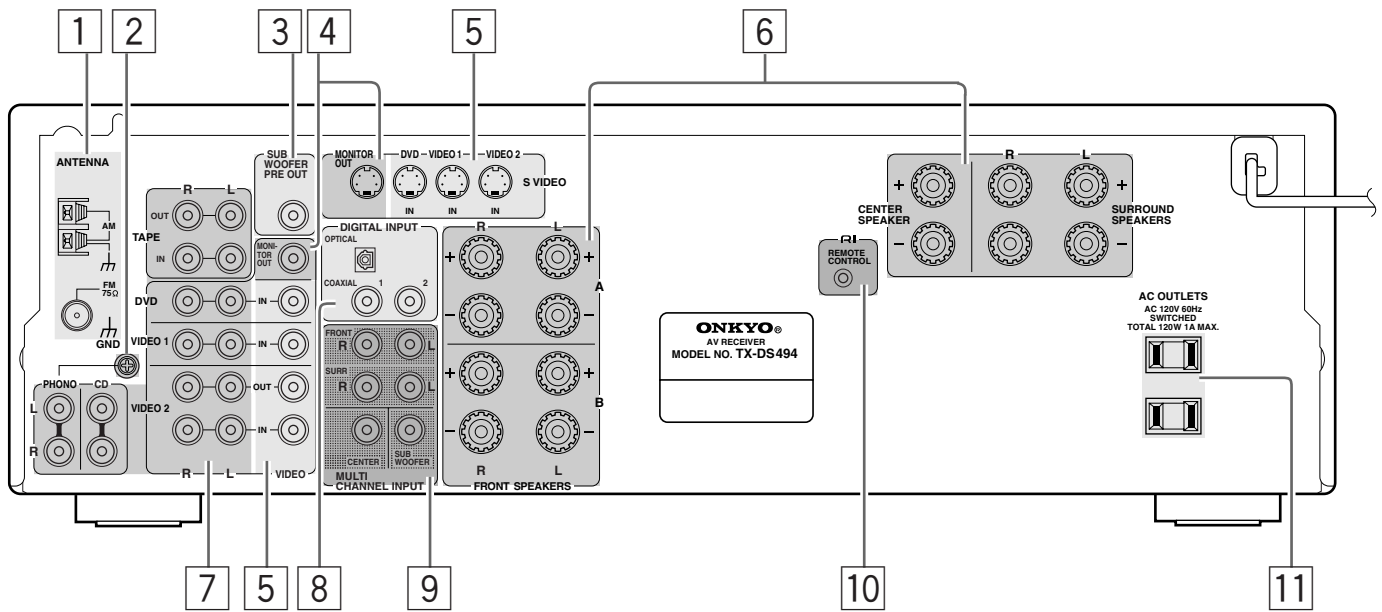

## 1 ANTENNA

These terminals are for connecting the FM antenna and AM antenna (refer to page 18).

## 2 GND

Use this GND terminal for connecting the ground (or earth) wire if a turntable is connected. Refer to "Connecting a turntable" on page 13.

## 3 SUB WOOFER PRE OUT

This terminal is for connecting an active subwoofer.

## 4 MONITOR OUT

The monitor output includes both RCA type and S video configurations. This output is for connecting television monitors or projectors.

## 5 VIDEO IN/OUT

There are 3 video inputs (each one includes both RCA type and S video configurations) and 1 RCA type video output. Connect DVD players, LD players, VCRs or other video components to the video inputs.

The video output channel can be used to be connected to video tape recorder for making recordings.

### RCA type jack



### S Video jack



## 6 SPEAKERS

Speaker terminals are provided for the front left, front right, center, surround left and surround right speakers. Speaker outputs are compatible with banana plug connectors (other than European models).

# Rear panel facilities

## 7 AUDIO IN/OUT

These are the analog audio inputs and outputs. There are 6 audio inputs (3 of which are linked to video inputs) and 2 audio outputs (1 of which are linked to a video output). The audio jacks are nominally labeled for turntables, compact disc players, cassette tape decks, and DVD players. To the audio jacks for VIDEO 1 and 2 connect the audio output from LD players, VCRs or other video components. The audio inputs and outputs require RCA type connectors.

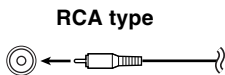

- When connecting a VCR or other video component, make sure you connect the audio and video leads together (i.e., both to VIDEO 1).
- The PHONO jacks are designed for use with turntables that use moving magnet cartridges.

## 8 DIGITAL INPUT (OPTICAL/COAXIAL)

These are the digital audio inputs. There are 2 digital inputs with coaxial jacks and 1 with optical jacks. The inputs accept digital audio signals from a compact disc, LD, DVD, or other digital source component.

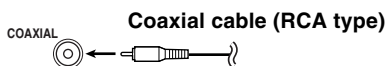
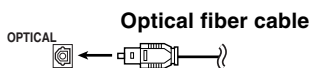

- When using the optical input jack, remove the protective cap and keep it safely. When the jack is not used, replace the protective cap.

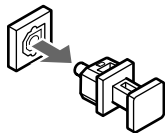

- When using an optical input jack, always use an optical fiber cable.
- When using the digital inputs, make sure to also connect the analog connections whenever possible.

## 9 MULTI CHANNEL INPUT

By connecting a DVD player, MPEG decoder, or other component that has a multi channel port, you can playback the audio with 5.1 channel output. So, be sure to prepare a cable that can properly connect the TX-DS494 to the peripheral device.

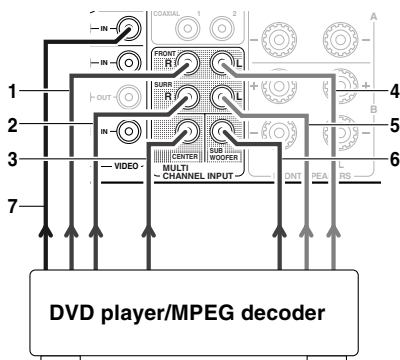

1. Front right
2. Surround right
3. Center
4. Front left
5. Surround left
6. Subwoofer
7. Video

- Connect the video output to one of VIDEO IN connectors (DVD, VIDEO 1 and VIDEO 2).

## 10 RI (REMOTE CONTROL)

Connect the Onkyo components that have **RI** connectors such as a CD player, and cassette tape deck using the **RI** cables provided with them. When these components are interconnected, they can be controlled from the remote controller provided with the TX-DS494.

After connecting the **RI** connectors, check the operation of the remote controller buttons for use in controlling other components (refer to page 30).

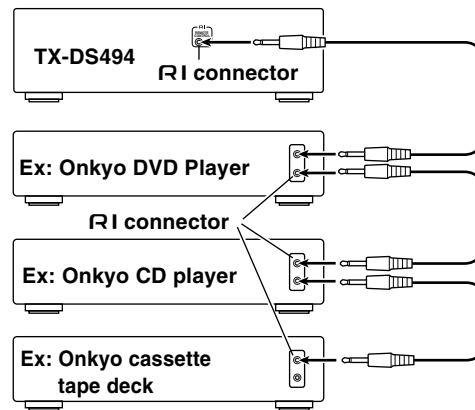

- For remote control operation, the audio connection cables must also be connected.
- The RC-443S or RC-444M remote controller does not support turntables.
- If the connected component has two **RI** connectors, you can use either one to connect to the TX-DS494. The other one can be used to daisy chain with another component.

## 11 AC OUTLETS

The TX-DS494 is supplied with AC mains outlets for connecting the power cords from other devices so that their power is supplied through the TX-DS494. By doing this, you can use the STANDBY/ON button on the TX-DS494 to turn on and off the connected devices as well.

The shape, number, and total capacity of the AC outlets may differ depending on the area of purchase.

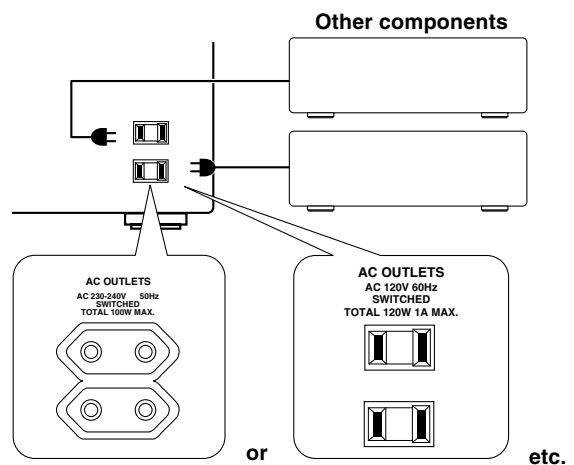

### Caution:

Make sure that the total capacity of the other components connected to this unit does not exceed the capacity that is printed on the rear panel (e.g., 120 watts).

# Example of how to connect your equipment

Here is explanation of how to connect the main components to the TX-DS494 in the standard manner. There are many ways that any one component can be connected, and it is up to you to decide which method best fits your situation. The directions given here are only one option and should only be thought of as such. It is best to fully understand the nature of each connector and terminal as well as each of your components and their features to ascertain which method of connection is best.

- Be sure to always refer to the instruction manual that came with the component that you are connecting.
- Do not plug in the power cord until all connections have been made.
- For input jacks, red connectors (marked R) are used for the right channel, white connectors (marked L) are used for the left channel, and yellow connectors (marked VIDEO) are used for video connection.
- Insert all plugs and connectors securely. Improper connections can result in noise, poor performance, or damage to the equipment.

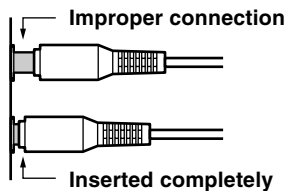

- Do not bind audio connection cables with power cords and speaker cables. Doing so may adversely effect the sound quality.

For a detailed explanation of how to connect the devices given below, refer to the pages listed.

**Speakers:** See page 17

**Radio antenna:** See page 18

## Setting the digital inputs

When connecting digital source components to the DIGITAL INPUT jacks on the rear panel, assign the input source button on the front panel to either a DIGITAL INPUT OPTICAL or COAXIAL jack depending on the type of connector on the digital source components. The DVD, CD, VIDEO 1, VIDEO 2 and TAPE inputs can be assigned to the DIGITAL INPUT jacks.

With the initial setting, the OPTICAL connector is assigned to the CD input, COAXIAL 1 is assigned to the DVD input and COAXIAL 2 is assigned to the VIDEO 1 input, and no input connector is assigned to the VIDEO 2 and TAPE inputs.

### Default setting

Input source	Digital input
CD	OPTICAL
PHONO	
AM	
FM	
TAPE	-----
VIDEO 2	-----
VIDEO 1	COAXIAL 2
DVD	COAXIAL 1

----- : Available for digital input but not set in initial setting.

 : Not available for digital input.

For example, follow the steps below to assign OPTICAL to the DVD device connected to the DIGITAL INPUT OPTICAL jack.

### 1. Press the DVD Input Selector button.

The DVD input is selected and "DVD" appears in the display.

DVD STEREO

### 2. Press the DIGITAL INPUT button.

The current DVD setting (COAX 1) appears.

DVD <- COAX 1

### 3. Press the DIGITAL INPUT button repeatedly to select "OPT".

DVD <- OPT

Pressing the DIGITAL INPUT button repeatedly will change the setting as follows:

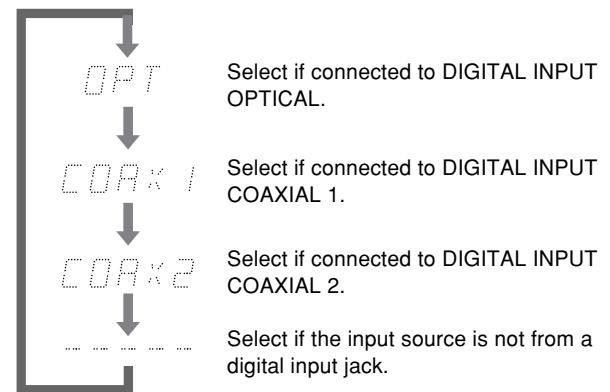

About five seconds after "OPT" is selected, the original display appears and the setting is completed.

If you have selected digital input, you can also select the input signal format (refer to "Setting the input signal format" on page 23).

### Note:

Do not assign a single DIGITAL INPUT jack to more than one source.

For example, if you assign the OPTICAL jack to the DVD input, since the OPTICAL jack is assigned to the CD input by the initial setting, it would result in assigning a single OPTICAL jack to both the CD and DVD inputs.

Whenever you assign a DIGITAL INPUT jack to a different source from the initial setting, be sure to change the initial setting for the jack in advance.

# Example of how to connect your equipment

## Connecting your audio components

### Connecting a turntable

Using an RCA-type audio connection cable, connect the output terminal on the turntable to the PHONO L/R jacks on the TX-DS494. Make sure that you properly connect the left channel to the L jack and the right channel to the R jack.

#### Note:

The TX-DS494 is designed for use with moving magnet cartridges. For proper operation, connect a ground (or earth) wire to the GND terminal. For some turntables, however, connecting the ground wire may cause increased noise, and in such a case, a ground wire is not necessary and should not be connected.

### Connecting a CD player

Using an RCA-type audio connection cable, connect the output terminal on the CD player to the CD L/R jacks on the TX-DS494. Make sure that you properly connect the left channel to the L jack and the right channel to the R jack.

If the CD player has a digital output jack as well, be sure to also connect it to either a DIGITAL INPUT OPTICAL or COAXIAL jack on the TX-DS494 depending on the type of connector on the CD player.

With the initial settings of the TX-DS494, the CD input source is set for digital input at the OPTICAL jack. If the digital connection is made at a different jack, this must be changed (see page 12).

### Connecting a cassette tape deck, MD recorder, DAT deck, or CD recorder

Using an RCA-type audio connection cable, connect the output terminals (PLAY) of the device to the TAPE IN L/R jacks on the TX-DS494 and the input terminals (REC) to the TAPE OUT L/R jacks. Make sure that you properly connect the left channel to the L jack and the right channel to the R jack.

If the device has a digital output jack as well, be sure to also connect it to either a DIGITAL INPUT OPTICAL or COAXIAL jack on the TX-DS494 depending on the type of connector on the device.

With the initial settings of the TX-DS494, the DIGITAL INPUT jack for the TAPE source is not assigned. If you connect the device to the DIGITAL INPUT jack, then this input source must be set for digital input at the DIGITAL INPUT button (see page 12).

## Example of audio equipment connections

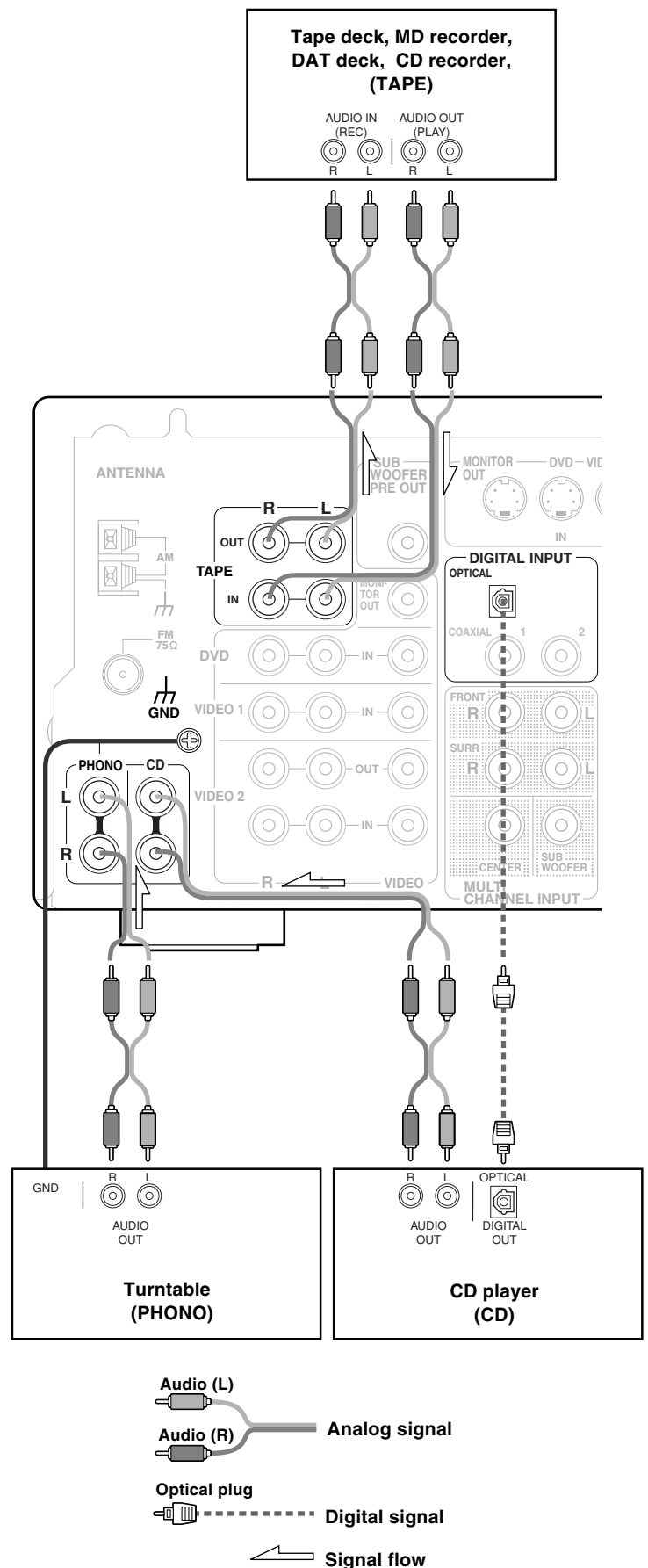

## Example of how to connect your equipment

---

### Connecting your video components

#### Connecting a DVD player or LD player

Using an RCA-type video connection cable, connect the video output terminal (composite) on the device to the DVD IN VIDEO jack on the TX-DS494.

If there is an S video output terminal on the DVD player or LD player, connect it to the DVD IN S VIDEO jack using an S video cable.

Using an RCA-type audio connection cable, connect the audio output terminal on the DVD player or LD player to the audio DVD IN L/R jacks on the TX-DS494. Make sure that you properly connect the left channel to the L jack and the right channel to the R jack.

If the DVD player or LD player has a digital output jack as well, be sure to also connect it to either a DIGITAL INPUT OPTICAL or COAXIAL jack on the TX-DS494 depending on the type of connector on the DVD player or LD player.

With the initial settings of the TX-DS494, the DVD input source is set for digital input at the COAXIAL 1 jack. If the digital connection is made at a different jack, this must be changed (see page 12).

#### Connecting a video cassette recorder

Using an RCA-type video connection cable, connect the video output terminal (composite) on the video cassette recorder to the VIDEO 2 IN VIDEO jack on the TX-DS494 and video input terminal to the VIDEO 2 OUT VIDEO jack.

If there is an S video output terminal on the video cassette recorder, connect it to the VIDEO 2 IN S VIDEO jack using an S video cable.

Using an RCA-type audio connection cable, connect the audio output terminal on the video cassette recorder to the same VIDEO 2 IN L/R jacks on the TX-DS494 and audio input terminal to the VIDEO 2 OUT L/R jacks. Make sure that you properly connect the left channel to the L jack and the right channel to the R jack.

If the video cassette recorder has a digital output jack as well, be sure to also connect it to either a DIGITAL INPUT OPTICAL or COAXIAL jack on the TX-DS494 depending on the type of connector on the video cassette recorder.

With the initial settings of the TX-DS494, the DIGITAL INPUT jack for the VIDEO 2 source is not assigned. If you connect the video cassette recorder to the DIGITAL INPUT jack, then this input source must be set for digital input at the DIGITAL INPUT button (see page 12).

#### Connecting a satellite tuner or television

Using an RCA-type video connection cable, connect the video output terminal (composite) on the satellite tuner or television to the VIDEO 1 IN VIDEO jacks on the TX-DS494.

If there is an S video output terminal on the satellite tuner or television, connect it to the VIDEO 1 IN S VIDEO jack using an S video cable.

Using an RCA-type audio connection cable, connect the audio output terminal on the satellite tuner or television to the same VIDEO 1 IN L/R jacks on the TX-DS494. Make sure that you properly connect the left channel to the L jack and the right channel to the R jack.

If the satellite tuner or television has a digital output jack as well, be sure to also connect it to either a DIGITAL INPUT OPTICAL or COAXIAL jack on the TX-DS494 depending on the type of connector on the satellite tuner or television.

With the initial settings of the TX-DS494, the VIDEO 1 input source is set for digital input at the COAXIAL 2 jack. If the digital connection is made at a jack different from the initial settings, this must be changed (see page 12).

#### Connecting a television monitor or projector

Using an RCA-type video connection cable, connect the video input terminal (composite) on the monitor to the MONITOR OUT VIDEO jack on the TX-DS494.

If there is an S video input terminal on the monitor, connect it to the MONITOR OUT S VIDEO jack using an S video cable.

# Example of how to connect your equipment

## Example of video equipment connections

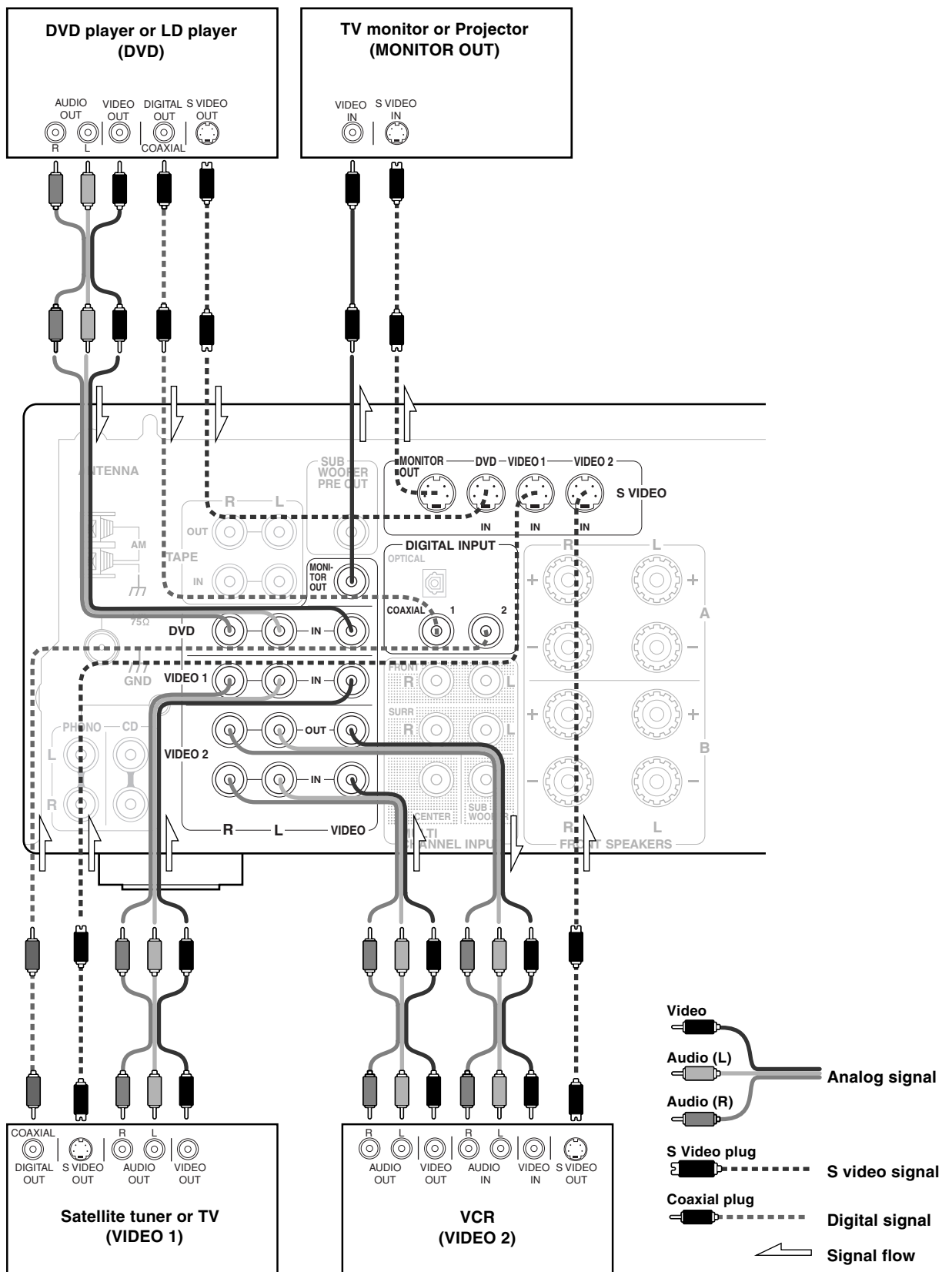

# Positioning speakers

This unit has two sets of speaker system terminals (for SPEAKERS A and SPEAKERS B).

Before connecting the speakers, place them correctly by consulting the instruction manuals that came with them.

For surround playback, the configuration and placement of your speakers are very important.

## Standard speaker system for reproducing surround sound

- **Front right and left speakers**
- **Center speaker**

Produces a rich sound image by serving as a sound source for the front right and left speakers and enhancing the sonic movement.

- **Surround right and left speakers**

Adds three-dimensional sonic movement and produces environmental sound associated with the background and effect sound for each scene.

- **Subwoofer**

Produces powerful and heavy bass.

## If the subwoofer and center speaker are not available

The sound recorded for the center speaker and the subwoofer will be properly distributed to the front right and left speakers for optimized surround playback.

## Speaker placement

Ideal speaker placement varies depending on the size of your room and the wall coverings. Here, only typical example of speaker placement and recommendations are shown.

### Important points regarding speaker placement

#### Front left and right speakers and center speaker

- Place these three speakers at the same height from the floor.
- Place each speaker so that sound is aimed at the location of the listener's ears at the listening position.
- Install the left and right front speakers at the same distance from the listening position.

#### Surround left and right speakers

- Place these speakers so that their height is 1 meter (3.3 feet) higher than that of the listener's ears.

#### Subwoofer

- The subwoofer can provide a similar sound effect regardless of the installation position, provided that it is installed within the room containing the listening position.

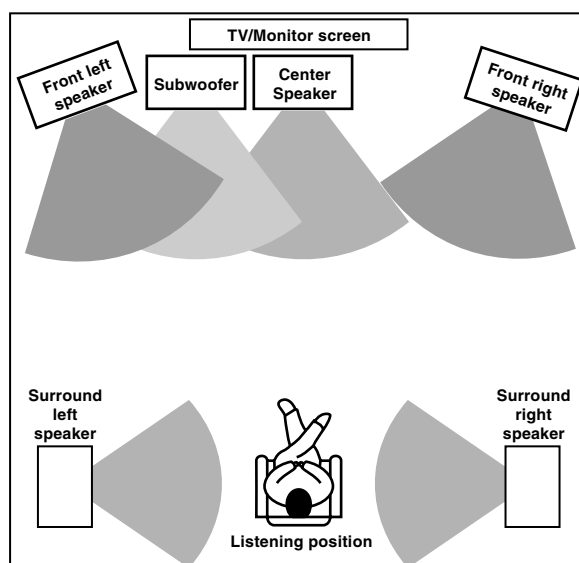



# Connecting speakers

## Connecting speakers

After installing the speakers, connect them to the TX-DS494.

**CAUTION:**  
**SPEAKER IMPEDANCE**  
 6 Ω min. per each speaker terminal.

### Preparation of speaker cords

- Strip away 15 mm (5/8 inch) of wire insulation.
- Twist wire ends very tight.

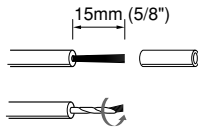

### Connecting the speaker cord

- Loosen the screw.
- Fully insert the end of the cord.
- Tighten the screw.

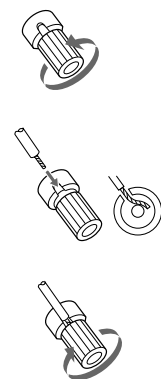

- To prevent damage to circuitry, never short-circuit the positive (+) and negative (-) speaker wire.



- Be sure to connect the positive and negative cables for the speakers properly. If they are mixed up, the left and right signals will be reversed and the audio will sound unnatural.
- Connect speakers with an impedance between 6 Ω and 16 Ω. Connecting speakers with an impedance less than 6 Ω may damage the TX-DS494.
- Do not connect more than one speaker cable to one speaker terminal. Doing so may damage the TX-DS494.
- When you are using only one speaker or when you wish to listen to monaural (mono) sound, a single speaker should never be connected in parallel to both the right and left-channel terminals simultaneously.

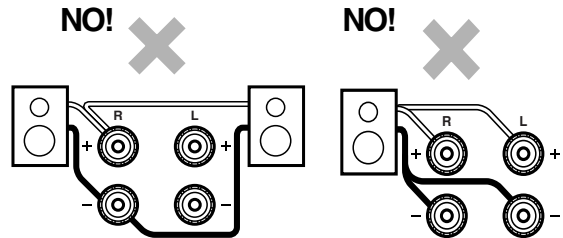

## Connecting a subwoofer

Use the SUB WOOFER PRE OUT jack to connect a subwoofer with a built-in power amplifier.

If your subwoofer does not have a built-in amplifier, connect an amplifier to the SUB WOOFER PRE OUT jack and the subwoofer to the amplifier.

## Connecting to SPEAKERS A

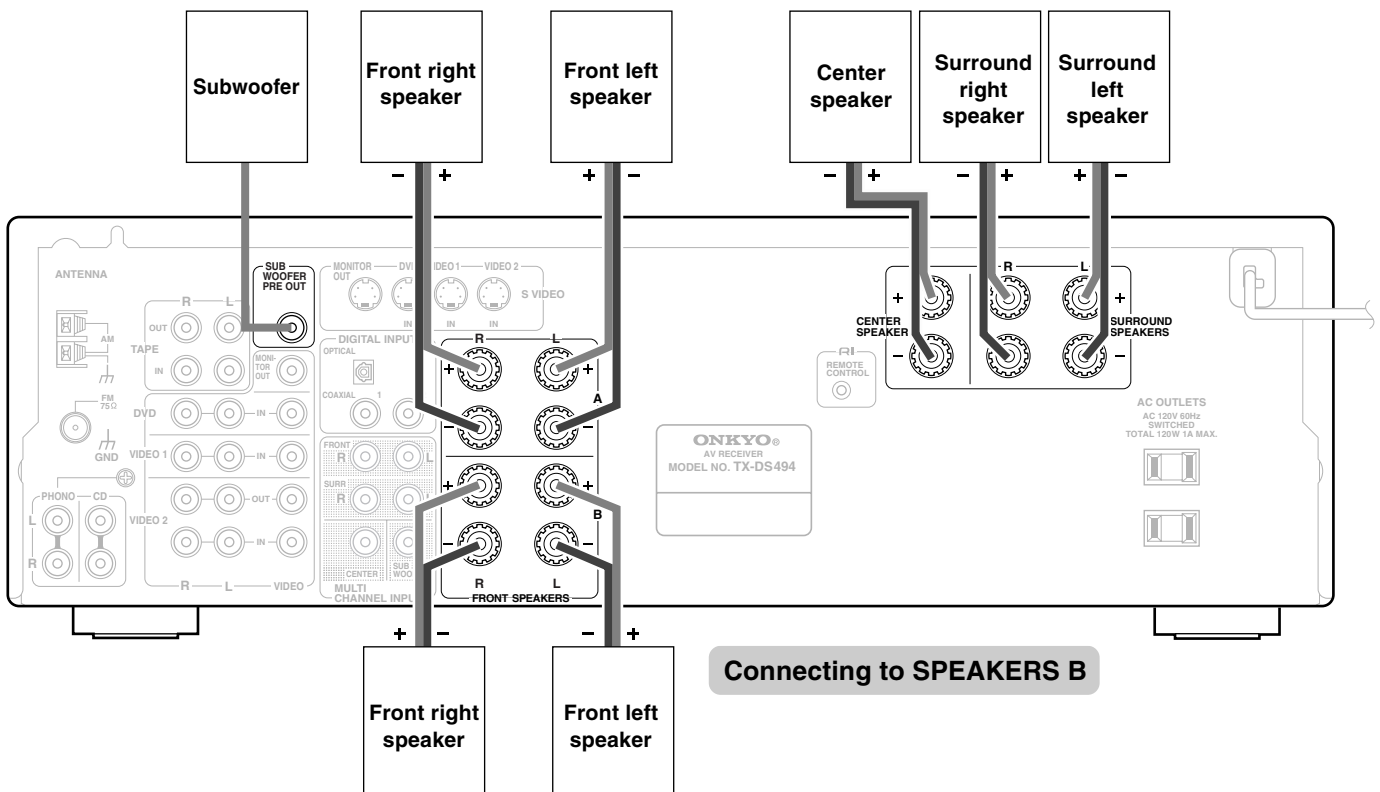

## Connecting to SPEAKERS B

# Connecting antennas

To use the tuner of TX-DS494, it is necessary to prepare the supplied FM and AM antennas.

- Adjustment and placement of the FM and AM antennas for better reception must be done while listening to a station broadcast.
- If better reception cannot be obtained, then placement of an outside antenna is recommended.

## Connecting the FM indoor antenna

North American models:

1. Strip away the insulation from the end of the cord.



2. Fully insert the stripped end of the cord.

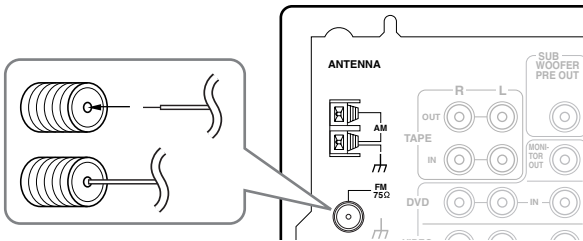

Except for North American models:

Fully insert the end of the cord.

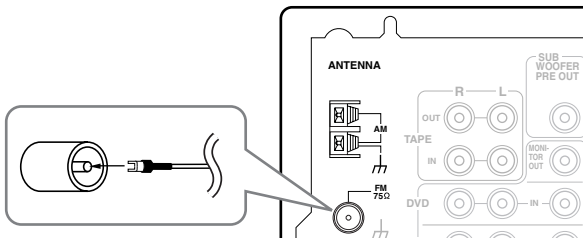

The FM indoor antenna is for indoor use only. During use, extend the antenna and move it in various directions until the clearest signal is received. Fix it with push pins or similar implements in the position that will cause the least amount of distortion.

If the reception is not very clear with the attached FM indoor antenna, the use of an outdoor antenna is recommended.

## Assembling the AM loop antenna

1. Rotate the outer frame of the antenna.

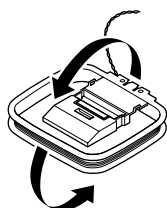

2. Insert the bottom edge of the outer frame into the groove on the stand.

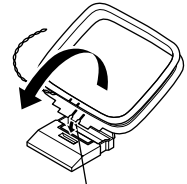

Insert into the groove.

3. Extend the antenna cord.

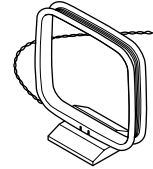

## Connecting the AM loop antenna

1. Press down the lever.

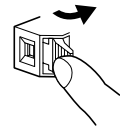

2. Insert the end of the cable into the hole.

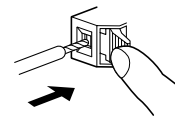

3. Release the lever.

The lever will return to the original position.

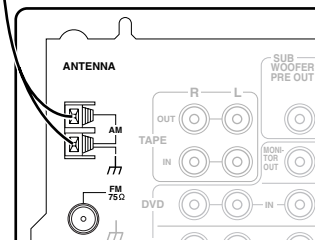
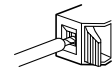

Either of the split ends of the AM antenna can be connected to either terminal. Unlike speaker cabling, there is no polarity for AM broadcast signals.

The AM loop antenna is for indoor use only. Set it in the direction and position where you receive signals clearly. Put it as far away as possible from the TX-DS494, televisions, speaker cables, and power cords.

When reception is not satisfactory with the attached AM loop antenna alone, connection of an outdoor antenna is recommended.

# Connecting antennas

If the reception condition cannot be improved by adjusting the provided antenna, install an outdoor antenna and connect it to this unit.

## Connecting an FM outdoor antenna

Please make sure that you follow the considerations:

- Keep the antenna away from noise sources (neon signs, busy roads, etc.).
- It is dangerous to put the antenna close to power lines. Keep it well away from power lines, transformers, etc.
- To avoid the risk of lightning and electrical shock, grounding is necessary. Follow item 14 of the “Important Safeguards” on page 2 when you install the outdoor antenna.

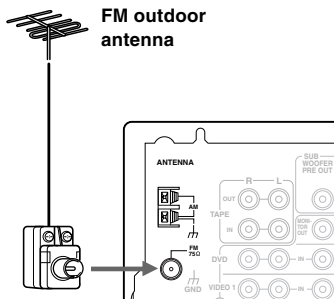

## Directional linkage

Do not use the same antenna for both FM and TV (or VCR) reception since the FM and TV (or VCR) signals can interfere with each other. If you must use a common FM/TV (or VCR) antenna, use a directional linkage type splitter.

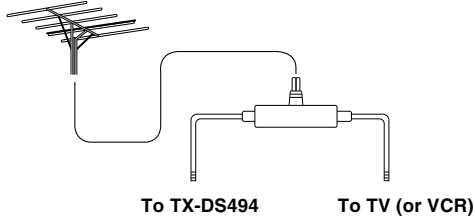

## Connecting the antenna cable to the 75/300 Ω antenna adapter (Worldwide models only)

### Connecting the coaxial cable

1. Prepare the coaxial cable as shown in the diagram.

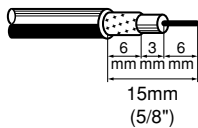

2. With your fingernail, or a small screwdriver, press the stoppers of the 75/300 Ω antenna adapter outward and remove the cover.



3. Connect the 75/300 Ω antenna adapter to the coaxial cable.

Clamp with radio pliers, etc.

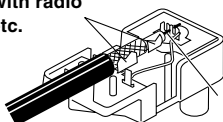

Push in the extremity of the conductor wire.

4. Cut the ferrite core wire.

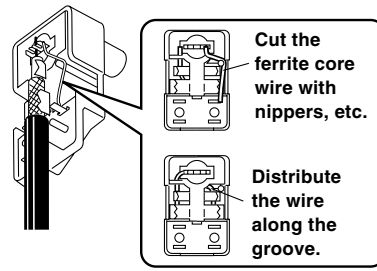

5. Reinstall the cover.

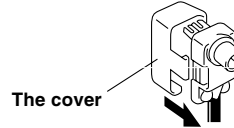

### Connecting the 300 Ω ribbon wire

1. Loosen the screws with a screwdriver.

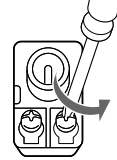

2. Wrap the wire around these screws.

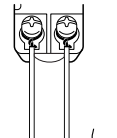

3. Tighten the screws with a screwdriver.

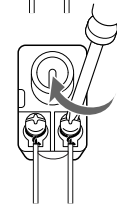

## Connecting an AM outdoor antenna

An outdoor antenna will be more effective if it is stretched horizontally above a window or outside.

AM loop antenna (Indoor)

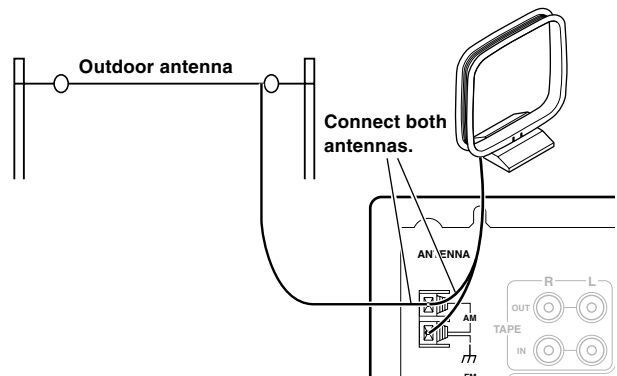

### Notes:

- Do not remove the AM loop antenna.
- To avoid the risk of lightning and electrical shock, grounding is necessary. Follow item 14 of the “Important Safeguards” on page 2 when you install the outdoor antenna.

# Connecting the power

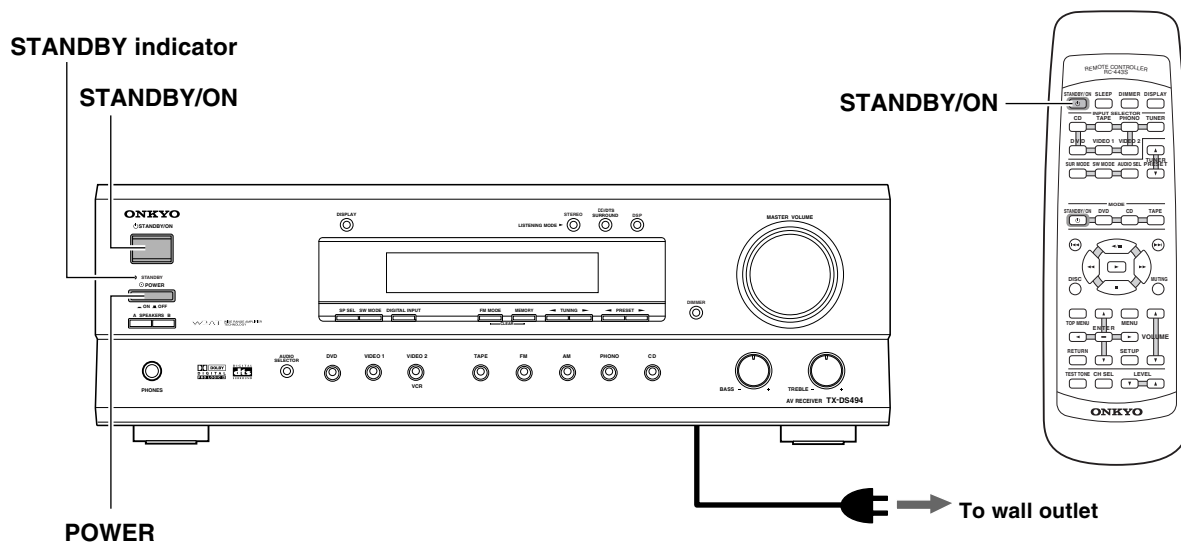

## Connecting the power

- The TX-DS494 is shipped with the main power (POWER) switch in the on position (■ ON). When the power cord is plugged in for the first time, the TX-DS494 will automatically enter the standby state and the STANDBY indicator will light (same condition after step 2 below).
- Before you plug in the TX-DS494, confirm that all connections have been made properly.
- Turning on the power may cause a momentary power surge, which might interfere with other electrical equipment on the same circuit, such as computers. If this happens, use a wall outlet on a different circuit.

### 1. Plug the power cord into an AC wall outlet.

### 2. Press the POWER switch to set the TX-DS494 to standby state.

The STANDBY indicator lights up.

### 3. Press the STANDBY/ON button to turn on the TX-DS494.

The display lights up and the STANDBY indicator turns off.

If you press the STANDBY/ON button again, the receiver returns to standby mode.

## Turning the power on from the remote controller

Before you can use the remote controller, you must perform steps 1 and 2 above and place the TX-DS494 in the standby state.

### Press the STANDBY/ON button on the remote controller to turn on the TX-DS494 (take it out of the standby state).

- To return the TX-DS494 to the standby state, press the STANDBY/ON button on the remote controller.

## Turning this unit ON from an RI-connected component

When the DVD player, CD player or MD recorder connected with the TX-DS494 through **RI** cables is turned on, the TX-DS494 automatically turns on and selects the source that was turned on. Turning the TX-DS494 off sets the **RI**-connected DVD player, CD player or MD recorder to standby mode.

When the TX-DS494 is already on, pressing the play button on the DVD player, CD player, cassette deck or MD recorder merely selects the input source that was played.

### Notes:

- The function of turning on the TX-DS494 is not available if its POWER switch is set to the off position (■ OFF) or the source components is not connected properly. When controlling the TX-DS494 from an **RI**-connected component, make sure that the POWER switch of this unit is set to the on position (■ ON) and that the component is connected properly.
- When a cassette tape deck or MD recorder is connected with the **RI** connector of this unit, it can be controlled from the source component selected with the TAPE button.
- Certain component models may not be able to control the TX-DS494.

## Memory preservation

This unit does not require memory preservation batteries. A built-in memory power backup system preserves the contents of the memory during power failures and even when the POWER switch is set to off. The POWER switch must be set to on in order to charge the backup system.

The memory preservation period after the unit has been turned off varies depending on climate and placement of the unit. On the average, memory contents are protected over a period of a few weeks after the last time the unit has been turned off. This period is shorter when the unit is exposed to a highly humid climate.

# Speaker Setup

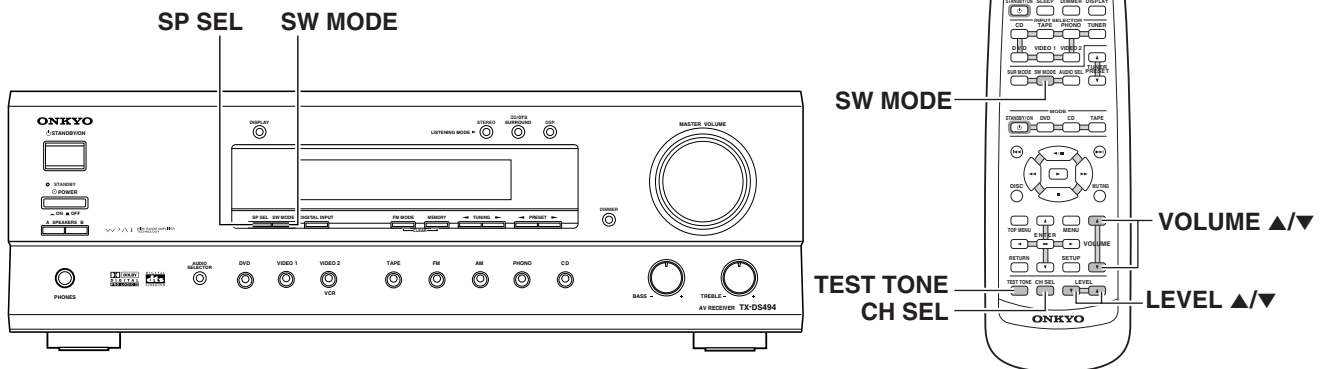

You need to set up the speaker configuration for the speaker system connected to the SPEAKERS A terminals (see page 17).

## Notes:

- The speakers cannot be set up for optimum audio reproduction if;
  - Headphones are connected (see page 8), or
  - The SPEAKERS B system is On (see page 7).
- It is not necessary to set up again once you have completed the setup unless you change the speaker configuration.

### Selecting the speaker configuration

Press **SP SEL** button repeatedly to select the number of channels for the **SPEAKERS A** system.

When the button is pressed, the current speaker setup will be displayed for about 5 seconds. If you want to change it, press the same button again within the 5 seconds.

When the button is pressed repeatedly, the number of channels changes as follows:

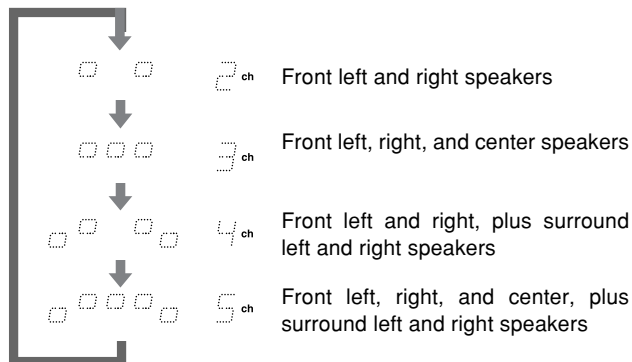

### Setting the subwoofer mode

Press **SW MODE** button repeatedly to select the subwoofer mode.

When the button is pressed, the current subwoofer mode will be displayed for about 5 seconds. If you want to change it, press the same button again within the 5 seconds.

When the button is pressed repeatedly, the subwoofer mode changes as follows:

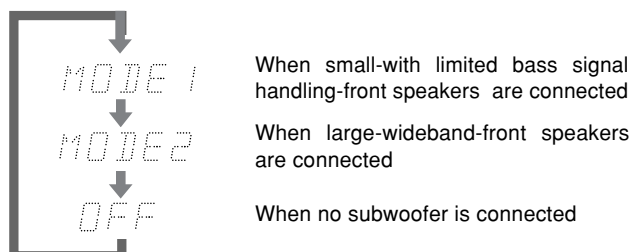

## Note:

When the subwoofer mode is set to **MODE 2** and audio is reproduced in the **STEREO** mode, the subwoofer may not output audio from certain sources (2 channel-Dolby Digital/DTS source etc.).

### Adjusting each speaker's relative volume balance (Remote controller only)

Adjust each speaker's relative volume balance so that the volume of all speaker's test tones sound equal at the listening position.

#### 1. Press the TEST TONE button.

Adjust the volume by gently increasing it with the **VOLUME ▲** button. Each speaker produces the test tone (pink noise) in the following order:

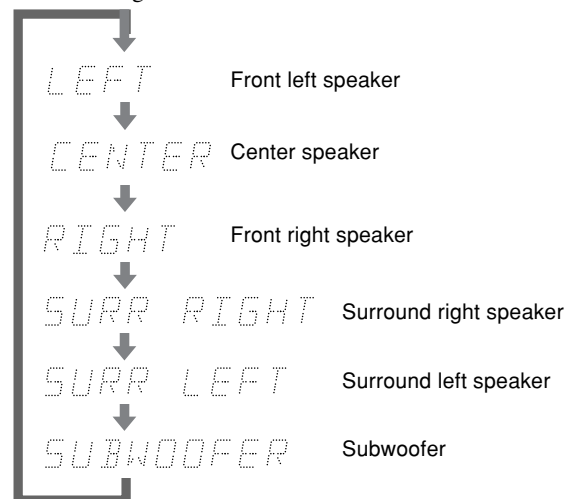

#### 2. To adjust the level of each speaker, press the CH SEL button to select a speaker and press the LEVEL ▲/▼ buttons to raise or lower the level.

The test tone should sound at the same level when you hear it in your listening position. You can adjust the level in the range between  $-12$  dB to  $+12$  dB.

#### 3. Press the TEST TONE button to complete adjustment.

# Selecting a sound source

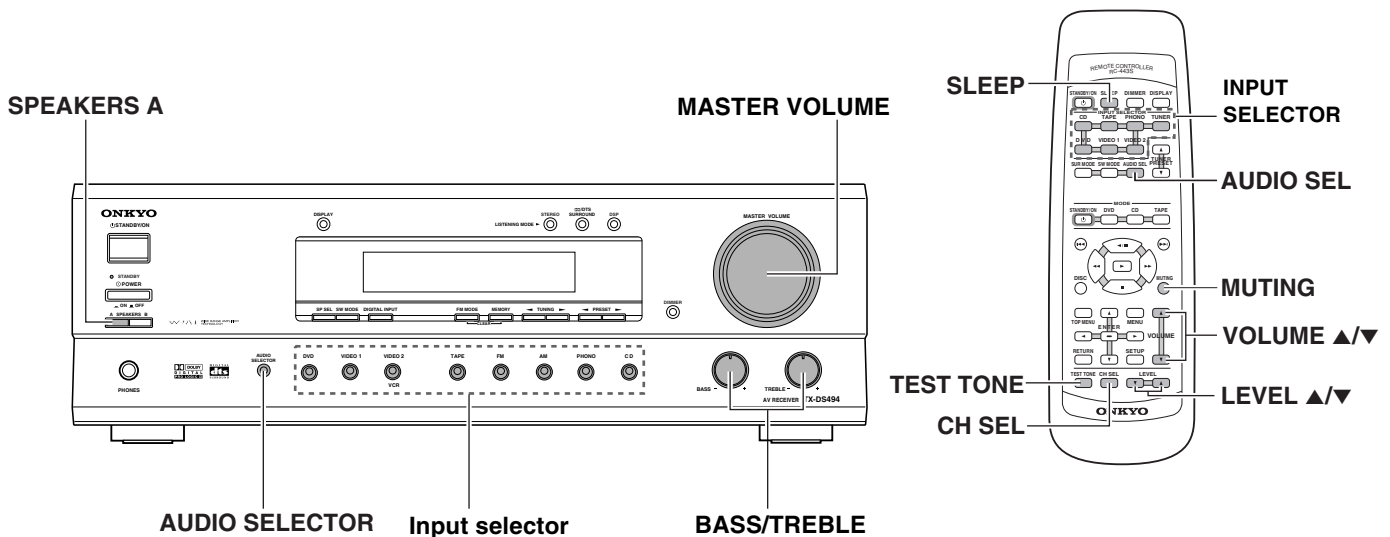

## Selecting a sound source

### 1. Press the desired input selector button.

The selected source name appears in the display.

If the TAPE button is pressed, either the TAPE or MD input which has been selected beforehand will be displayed. The TAPE and MD sources can be switched alternately by holding the TAPE button for about 2 seconds.

### 2. When the selected source is other than FM, AM or PHONO, press the AUDIO SELECTOR button on the front panel or the AUDIO SEL button on the remote controller to select an audio input signal format.

Each time the button is pressed, the setting cycles; "AUTO" → "MULTI CH" → "ANALOG" → "AUTO" (back to the beginning) (refer to page 23).

### 3. Make sure that the SPEAKERS A indicator lights up in the display.

If it does not light, press the SPEAKERS A button.

### 4. Start playing the selected input source.

Follow the operating instructions for the source device.

### 5. Adjust the volume with the MASTER VOLUME dial on the front panel or the VOLUME ▲/▼ buttons on the remote controller.

Turn the MASTER VOLUME dial clockwise to increase the volume or counterclockwise to decrease it.

### 6. Adjust the tone with the BASS and TREBLE control knobs on the front panel.

Turn the BASS and TREBLE control knobs to adjust the bass and treble response from the Front speakers (refer to page 8).

#### Note:

If you hear no sound from the speakers, check the following items:

- Make sure that all devices and speakers are connected correctly and securely.
- The sound is muted when the MUTING indicator flashes. Press the MUTING button on the remote controller to cancel the mute function (refer to page 23).
- When you select a source that is connected to the DIGITAL INPUT jacks on the rear panel, you must select digital input (refer to page 12).

## Using MULTI CHANNEL INPUT

The MULTI CHANNEL INPUT refers to a system, which is compatible with a source component equipped with 5.1-channel outputs (DVD player, MPEG decoder, etc.), reproducing the left/right front, center and left/right surround channels from five respective speakers and outputting the subwoofer channel from SUB WOOFER PRE OUT (refer to page 11).

### 1. Press AUDIO SELECTOR button repeatedly to select "MULTI CH".

### 2. Turn on the component connected to the MULTI CHANNEL INPUT port and start playing the desired media.

### 3. If necessary, press the CH SEL button on the remote controller to select an individual speaker. Then press the LEVEL ▲/▼ button to adjust the output level as desired.

Adjust the speaker output level so that you can hear the same sound level from each speaker at the listening position. For the front right, front left, center, surround right and surround left speakers, the output levels can be adjusted between -12 to +12 dB. The subwoofer can be adjusted between -30 to +12 dB.

The volume levels from the speakers reproducing MULTI CHANNEL INPUT are independent from the speaker levels set using the test tone (page 21). These settings are not applied to speakers reproducing MULTI CHANNEL INPUT.

#### Notes:

- MULTI CH cannot be selected when FM, AM or PHONO is selected as the input source.
- The surround mode cannot be selected when MULTI CH is selected. Also, if MULTI CH is selected during use of a surround mode, it is canceled automatically.
- If the speaker level is set to +1 dB or higher, the maximum level indicated in the display will change if you raise the volume level.
- Regardless of the speaker configuration, the input signal will be output to each corresponding speaker. For example, even if the speaker configuration is set to 2 ch, sound comes from all speakers.

## Selecting a sound source

### Setting the input signal format

If the input source is DVD, CD, VIDEO 1, VIDEO 2 or TAPE, you can specify the input signal format.

With the initial setting, AUTO is assigned to the DVD, CD and VIDEO 1 inputs, and ANALOG is assigned to the TAPE and VIDEO 2 inputs. You can change this according to the signal format of the input source.

**For example, follow the steps below to specify the input signal format for the VIDEO 2 input:**

#### 1. Press the VIDEO 2 button.

VIDEO 2 is selected as the input source and “VIDEO 2” appears in the display.

#### 2. Press the AUDIO SELECTOR button.

The current setting is displayed.

#### 3. Press the AUDIO SELECTOR button repeatedly until the desired input signal format is displayed.

Each press of the button switches the displayed input format as follows. AUTO is skipped when the selected input is not assigned to the DIGITAL INPUT jacks (refer to page 12).

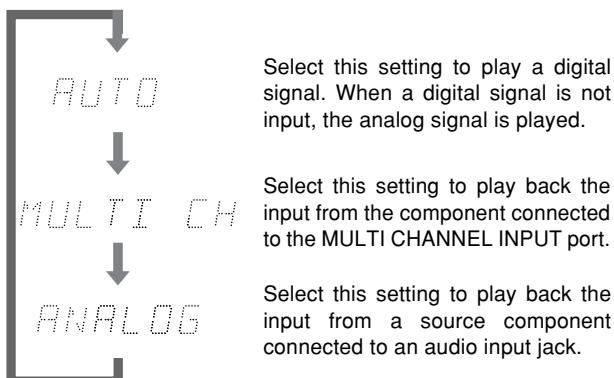

After 5 seconds, the original display appears and the setting is completed.

#### Notes:

- With ANALOG setting, even if a digital signal is input from the same component, only the analog signal will be output.
- When a digital input setting is changed while an input signal format other than MULTI CH is set, the digital input becomes automatically ANALOG if it has been “-----” or “AUTO” if it has been “OPT”, “COAX 1” or “COAX 2”.

### Sleep function (Remote controller only)

The sleep timer can turn off the power to the system after a specified time period.

#### Press the SLEEP button on the remote controller.

The SLEEP indicator will light and “SLEEP 90 MIN” (the TX-DS494 will turn off after 90 minutes) appears in the display.

SLEEP 90 MIN

- Pressing the SLEEP button each time reduces the time value in 10-minute increments.
- To cancel the sleep function, press the SLEEP button when the time displayed is less than 10 minutes.
- While the sleep function is enabled, you can press the SLEEP button to see how much time is left.

### Mute function (Remote controller only)

The muting function can turn down the playback sound immediately. This can be useful, for example, when you receive a telephone call while listening to music or another source.

#### Press the MUTING button on the remote controller.

The MUTING indicator will flash and the sound from the speakers or headphones will be switched off by the receiver’s audio muting circuits.

MUTING

Press the MUTING button again to turn the sound back on.

#### Note:

The mute function will be cancelled if you turn off the TX-DS494.

# Listening to Radio Broadcasts

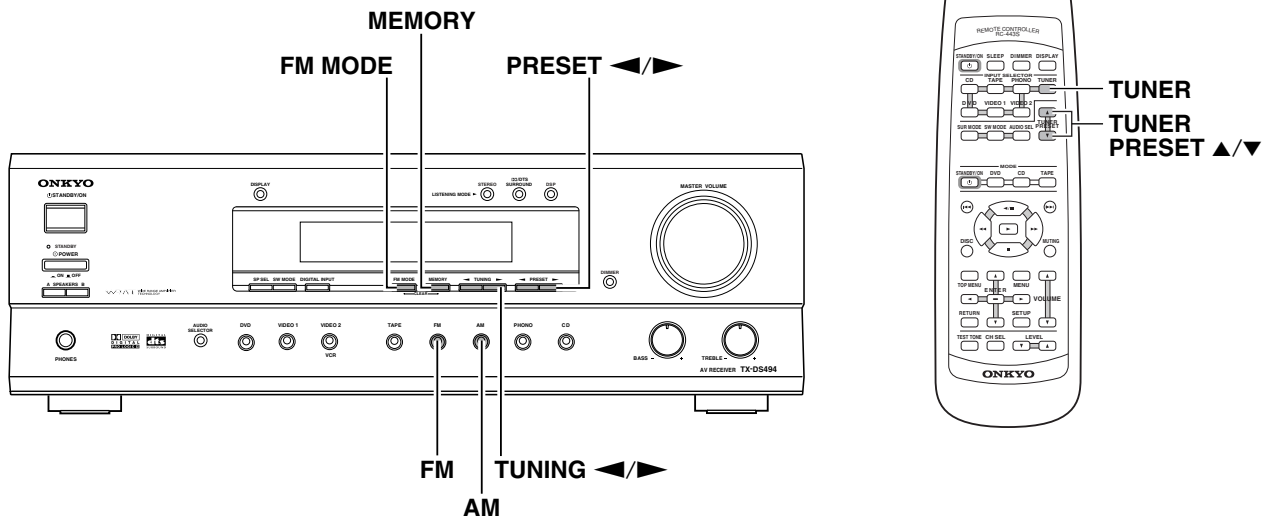

## Listening to FM/AM radio stations

FM and AM broadcasting can be received either by tuning into a station or selecting a preset station.

### AM

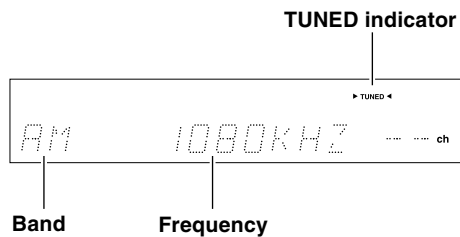

### FM

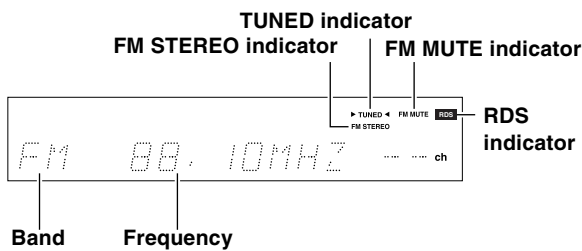

## Tuning into a radio station

1. Press either the **AM** or **FM** input selector button.
2. Using the **TUNING** ◀/▶ buttons on the front panel, tune into the station you desire.

When you tune into a radio station, TUNED indicator appears in the display. If you tune into an FM station in stereo, then FM STEREO indicator lights up.

- The tuner frequency changes in 50 kHz increments for FM and 10 kHz (or 9 kHz) increments for AM.
- When tuning into FM stations, you can press the TUNING ◀/▶ button continuously for more than 0.5 seconds to scan for an FM station in the direction of the button you pressed (FM auto tuning mode). After you release the button and a station is received in stereo, the scanning stops.

### If no FM station can be tuned in automatically:

If the signal is weak or is too noisy, press the FM MODE button to cancel the FM MUTE function. This turns the FM MUTE indicator off and initiates the monaural reception mode. In this mode, noise between stations is audible but sound interruption experienced in the stereo reception mode is removed.

To return to the stereo reception mode, press the FM MODE button so that the FM MUTE indicator lights up.

## Receiving RDS (European models only)

When an RDS (Radio Data System) station broadcasting PS (Program Service Name) information is received, the RDS indicator lights up and the name of the station is displayed.

- RDS reception is only available on the European models, and only in areas where RDS broadcasts are available.



# Listening to Radio Broadcasts

## Presetting a radio station

By storing (presetting) frequently received radio stations, they can be received automatically by pressing the PRESET ◀/▶ button on the front panel or TUNER PRESET ▲/▼ buttons on the remote controller.

Up to a total of 30 FM and AM stations can be preset.

### 1. Tune into the radio station you desire.

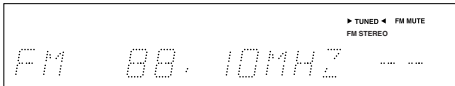

2. Press the MEMORY button and, while the MEMORY indicator lights, press the PRESET ◀/▶ button to select the preset number (one of 1 to 30) to be used with the station to be preset.

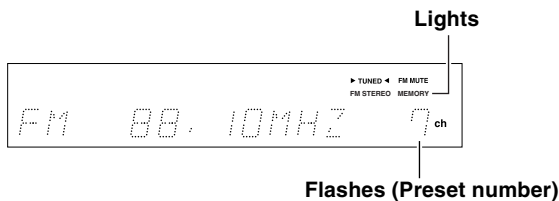

3. Press the MEMORY button to finalize the procedure.

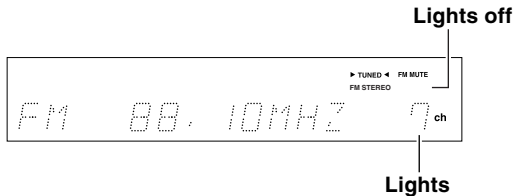

This programs the radio station as a preset radio station.

## Selecting a preset radio station

### 1. Press either the AM or FM input selector button.

The display should show the currently selected frequency. If it displays the listening mode, press the DISPLAY button to display the frequency.

### 2. Using the PRESET ◀/▶ buttons, select the number of the desired preset station.

## When using the remote controller

### 1. Press the TUNER input selector button on the remote controller.

### 2. Press the TUNER PRESET ▲/▼ buttons and select the number of the desired preset station.

## Erasing a preset radio station

### 1. Select the preset radio station that you want erase.

Refer to "Selecting a preset radio station" above.

### 2. Press the FM MODE button while holding down the MEMORY button.

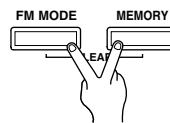

- Once the preset station has been cancelled, the memory location can be used to store another station.

# To enjoy Surround mode

The TX-DS494's surround sound enables you to enjoy the presence of a movie theater or concert hall in your room.

Before using a surround mode, make sure the speaker setup has been set (refer to page 21).

The configuration of the speakers are very important for the surround sound. Refer to "Positioning speakers" on page 16 and "Connecting speakers" on page 17.

## Surround modes

### DOLBY DIGITAL Surround, DTS (Digital Theater System) Surround

This 5.1-channel digital surround format enables you to individually record and play five full-range (20 Hz-20 kHz) channels (left and right front, center, two surround channels) plus an LFE channel (Low Frequency Effect) for the low-range effect sound. It will create a realistic sound that could be heard in the theaters and concert halls.

**DOLBY DIGITAL:** Select this option when you play a DVD video that has a  mark.

**DTS:** Select this option when you play a DVD player, laser disc, or CD that has a  mark.

### DOLBY PRO LOGIC II surround

This is a 5-channel surround system of a new generation, casting a bridge between the previous 4-channel (Left/Right Front, Center and monaural surround channels) Pro Logic surround and 5.1-channel Dolby Digital surround. Dolby Pro Logic II provides the MOVIE mode optimized for viewing movies and the MUSIC mode optimized for listening to music. In the MOVIE mode, the surround channel, which has been monaural and based on narrow band, is reproduced in stereo so that the feeling of movement in the played movies is more enhanced. In the MUSIC mode, the surround channel reproduces natural sound field even with 2-channel music sources.

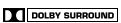
The MOVIE mode allows you to enjoy VHS and DVD software carrying the  marking as well as some of TV broadcast programs. The MUSIC mode allows you to enjoy stereo music from CD, etc.

### Analog/PCM (Pulse Code Modulation) surround

Analog sources include the audio records, AM/FM broadcasting and cassette tapes. The PCM (Pulse Code Modulation) signal is a kind of digital audio signal, which is recorded directly on CD or DVD without being compressed. When an analog or PCM source is played, you can enjoy unique surround modes to Onkyo as listed below.

**ORCHESTRA:** This mode is suitable for classics and opera music. The center channel is cut and the surround channels are emphasized to widen the stereo image. It will simulate a natural reverberation that can be created in a large hall.

**UNPLUGGED:** This mode is suitable for acoustic instrumental sounds, vocals, and jazz music. By emphasizing the front stereo image, it will simulate the acoustics in front of the stage.

**ALL CH ST:** This mode is useful for background music. The front and surround channels will create a stereo image.

## Notes on DTS

- If you play a CD or LD that supports DTS when the "ANALOG" setting is selected on the TX-DS494, the DTS encoded signal will not be decoded and noise will be output. This noise could damage the amplifier and speakers. Therefore, be sure to select "AUTO" and use the DIGITAL INPUT jacks (OPTICAL/COAXIAL) to connect the DTS source. (Refer to "Setting the input signal format" on page 23.)
- If you play a CD or LD that supports DTS when the "AUTO" setting is selected, you may hear a noise for a short while until the DTS decoder recognizes the DTS encoded signal and starts operating. This is not a malfunction.
- If you press the pause or skip button on the player while playing a DTS source, a short noise may be heard. This is not a malfunction.
- The DTS indicator on the TX-DS494 lights up while it plays the DTS source. When playback concludes and the DTS signal transmission stops, the TX-DS494 remains in DTS mode and the DTS indicator remains lit. This prevents noise when you operate the pause or skip button on the player. Therefore, if the source switches from the DTS signal to the PCM signal immediately, the PCM signal may not be played. In this case, stop the playback of the source on the player for about 3 seconds, then resume playback.
- Some CD players and LD players may be unable to play DTS sources correctly even if you connect the player to the TX-DS494 digitally. This is because the digital signal has been processed (such as the output level, sampling frequency, frequency response, etc.), and the TX-DS494 cannot recognize the signal as DTS data. Therefore, you may hear noise when you play a DTS source while processing the signal.
- The TAPE OUT or VIDEO 2 OUT jacks of the TX-DS494 output analog audio. Do not record CDs or LDs that support DTS using these jacks. Otherwise, you will record a DTS encoded signal as noise.

# To enjoy Surround mode

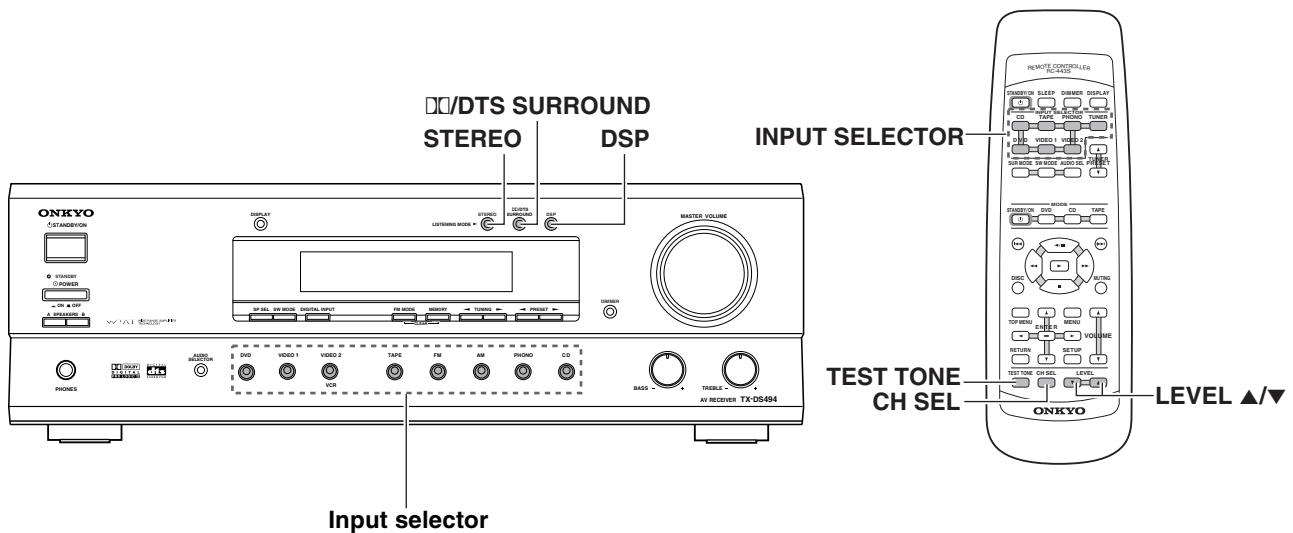

## Relationship between input sources and surround modes

The surround modes that can be selected are variable depending on the signal formats employed with the input sources.

Input source signal format	Analog	PCM*4	Dolby Digital*5	dts	MULTI CH*6
Source software	Tape, Record, Tuner	CD, Audio DVD, Video DVD	Video DVD, LD, Digital satellite broadcast	CD, LD, Video DVD	Video DVD
Listening mode					
STEREO*1	●	●	●	●	
PRO LOGIC II*2	●	●	●		
DOLBY D			●		
DTS				●	
ORCHESTRA*3	●	●			
UNPLUGGED*3	●	●			
ALL CH ST*3	●	●			
MULTI CH					●

\*1 Only STEREO can be selected when SP SEL is set to 2 ch, when SPEAKERS B is selected or when headphones are used.  
 \*2 When SP SEL is set to 3 ch, "3 ST" is displayed in place of "PL II".  
 \*3 These modes cannot be selected when SP SEL is set to 2 ch or 3 ch.  
 \*4 Only STEREO can be selected when the PCM source has been recorded with a sampling rate 96 kHz.  
 \*5 Only DOLBY D (PL II if the source is a 2-channel source) or STEREO can be selected when Dolby Digital surround audio is reproduced.  
 \*6 The surround mode cannot be selected when MULTI CH is selected.

### Selecting DOLBY PRO LOGIC II surround

1. Press an input selector button to select the desired sound source.
2. Press the **DOLBY/DTS SURROUND** button repeatedly to select DOLBY PRO LOGIC II.

The selected mode appears in the display. Each time you press the button, the surround mode changes as follows:



3. Play the selected sound source.

### You can adjust the level of each speaker.

1. Press the CH SEL button on the remote controller to select a speaker.
  2. Press the LEVEL ▲/▼ buttons on the remote controller to raise or lower the level.
- The speaker levels set here are cleared when this unit is set to STANDBY. (The speaker levels return to the levels set using the test tone.)
  - When the TEST TONE button on the remote controller is pressed after the above adjustment, the set levels will become the levels adjusted using the test tone by overwriting the existing ones.

## To enjoy Surround mode

### Selecting DOLBY DIGITAL/DTS surround

1. Press an input selector button to select the desired sound source.
2. Press the **DOLBY/DTS SURROUND** button.
3. Play the selected sound source.

#### You can adjust the level of each speaker.

1. Press the CH SEL button on the remote controller to select a speaker.
2. Press the LEVEL ▲/▼ buttons on the remote controller to raise or lower the level.
  - The speaker levels set here are cleared when this unit is set to STANDBY. (The speaker levels return to the levels set using the test tone.)
  - When the TEST TONE button on the remote controller is pressed after the above adjustment, the set levels will become the levels adjusted using the test tone by overwriting the existing ones.

#### Note:

Sources other than Dolby Digital/DTS-encoded ones are reproduced with Dolby Pro Logic II.

### Late Night function

Since the audio in movies produced for theaters has a big difference between the highest and lowest levels (dynamic range), it is sometimes necessary to increase the volume to a very high level when you want to listen to low-level audio such as environmental sounds and low human voices. In such a case, switch the Late Night function to ON to reduce the dynamic range so that even low-level audio can be identifiable without increasing the overall listening volume.

This function is especially convenient when you have to view a movie at a low volume in the night time, etc.

#### During Dolby Digital surround playback, press the DSP button.

Each press of the button switches the Late Night function ON and OFF alternately.

#### Notes:

- The Late Night function is available only in Dolby Digital Surround mode.
- The degree of the Late Night effect is already programmed into the source materials. Some materials may produce only small or no effects.

### Selecting Onkyo's surround modes

1. Press an input selector button to select the desired sound source.
2. Press the **DSP** button repeatedly until the desired surround mode name appears.

The selected mode appears in the display. Each time you press the button, the surround mode changes as follows:

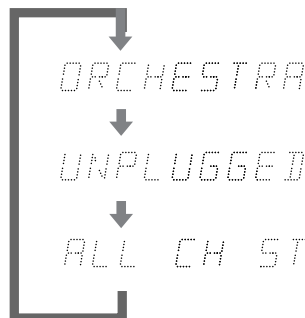

3. Play the selected sound source.

When software compatible with Dolby Digital is played, the surround mode will automatically switch to the DOLBY D surround mode. When software compatible with DTS is played, the surround mode will automatically switch to the DTS mode.

#### You can adjust the level of each speaker.

1. Press the CH SEL button on the remote controller to select a speaker.
2. Press the LEVEL ▲/▼ buttons on the remote controller to raise or lower the level.
  - The speaker levels set here are cleared when this unit is set to STANDBY. (The speaker levels return to the levels set using the test tone.)
  - When the TEST TONE button on the remote controller is pressed after the above adjustment, the set levels will become the levels adjusted using the test tone by overwriting the existing ones.

### Selecting STEREO modes

1. Press an input selector button to select the desired sound source.
2. Press the **STEREO** button.
3. Play the selected sound source.

# Recording a source

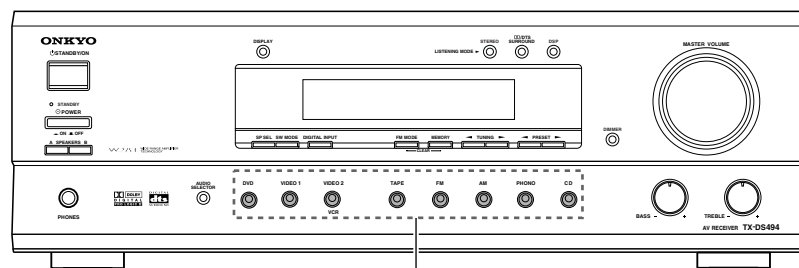

Input selector

**To record the input source signal you are currently watching or listening to**

Recording of video and/or audio signals can be performed on the components connected to the VIDEO 2 OUT and TAPE OUT (audio only) jacks.

**1. Press an input selector button to select the input source to record.**

The input source is now selected and you may watch or listen to it as desired. The currently selected input source signal to the TAPE OUT and VIDEO 2 OUT outputs for recording.

**2. Start recording at the recording component as desired.**

**Notes:**

- You can record analog audio, but not digital audio. Make sure that you have made a correct analog connection.
- If you change the input source during recording, you will record the signals from the newly selected input source.
- You cannot record the surround effects.
- You cannot record the source connected to the MULTI CHANNEL INPUT port.

**Recording the video from one source and the audio from another**

You can add the sound from one source to the video of another source to make your own video recordings.

Below is an example of recording the sound from a compact disc player connected to CD L/R jacks and the video from a video camera connected to VIDEO 1 IN VIDEO jack to video cassette tape in a video cassette recorder connected to the VIDEO 2 OUT L/R and VIDEO jacks.

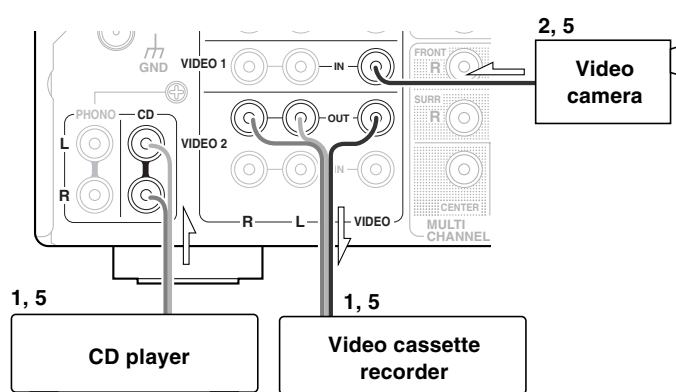

**1. Insert a CD in the CD player and insert a tape in the video camera connected to the VIDEO 1.**

**2. Insert a video tape for recording in the video cassette recorder connected to VIDEO 2 OUT.**

**3. Press the VIDEO 1 input selector button.**

**4. Press the CD input selector button.**

This switches the audio output to CD, but the video output remains VIDEO 1 that has been selected in step 3.

**5. Start recording on the video cassette recorder and start playing at the CD player and video camera as desired.**

The recorded video signal becomes the output from the video camera and recorded audio signal becomes that from the CD player.

**Notes:**

- You can record analog audio, but not digital audio. Make sure that you have made a correct analog connection.
- If you change the input source during recording, you will record the audio signals from the newly selected input source and the video signals assigned to that input source.
- You cannot record the surround effects.

# Using remote controller

You can operate the **RI**-connected Onkyo CD player, cassette tape deck or DVD player with the remote controller provided with the TX-DS494. The illustration shows the RC-443S remote controller.

## Controlling an Onkyo CD player

The **RI** connector of the Onkyo compact disc player must be connected to the TX-DS494 (refer to page 11).

1. Press the **CD MODE** button.
2. Press the **STANDBY/ON** button to turn on the Onkyo compact disc player.
3. Press the desired operation button.

- ▶ : Starts playback of CD.
  - : Stops playback, fast forward or fast reverse.
  - ▶▶ : Fast forwards the CD.
  - ◀◀ : Fast reverses the CD.
  - ◀|| : Lets playback pause temporarily.
  - ▶▶| : Skips to the beginning of the next track.
  - |◀◀ : Skips to the beginning of the current or previous track.
- DISC : This button is valid when the CD changer is used and selects the disc to be played.

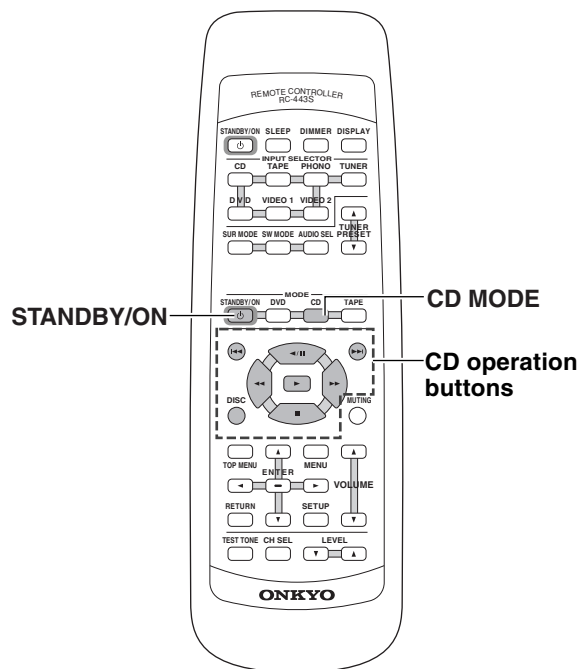

## Controlling an Onkyo cassette tape deck

The **RI** connector of the Onkyo cassette tape deck must be connected to the TX-DS494 (refer to page 11).

1. Press the **TAPE MODE** button.
2. Press the desired operation button.

- ▶ : Plays side A (the side facing the front) of tape.
- : Stops playback, recording, fast forward or rewinding.
- ▶▶ : Fast forwards the tape.
- ◀◀ : Rewinds the tape.
- ◀|| : Plays side B (the side facing the rear) of the tape.
- ▶▶| : Fast forwards the tape till the beginning of the next music.
- |◀◀ : Rewinds the tape till the beginning of the current or previous music.

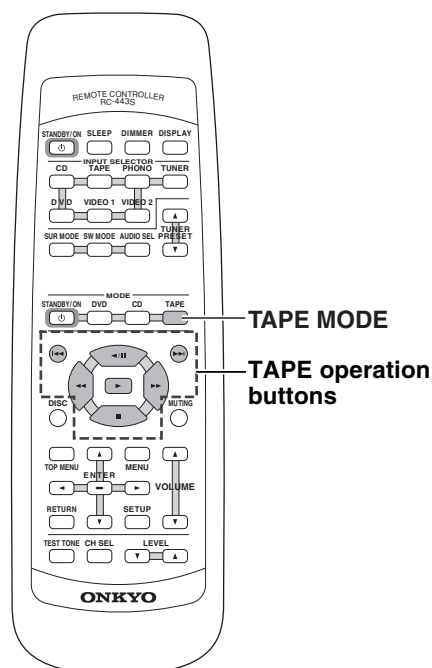

# Using remote controller

## Controlling an Onkyo DVD player

The **RI** connector of the Onkyo DVD player must be connected to the TX-DS494 (refer to page 11).

1. Press the **DVD MODE** button.
2. Press the **STANDBY/ON** button to turn on the Onkyo DVD player.
3. Press the desired operation button.

### DVD operation buttons

- ▶ : Starts playback of DVD.
- : Stops playback.
- ▶▶ : Searches the disc in the forward direction.
- ◀◀ : Searches the disc in the reverse direction.
- ◀|| : Lets playback pause temporarily or advances the disc frame by frame.
- ▶▶| : Starts playback from the beginning of the next chapter/track.
- |◀◀ : Starts playback from the beginning of the current chapter/track.

**DISC** : This button is valid when the DVD changer is used and selects the disc to be played.

### OSD operation buttons

- TOP MENU** : Displays the top menu of each DVD disc.
- MENU** : Displays a menu recorded in the DVD disc.
- RETURN** : Returns to the previous menu.
- SETUP** : Displays the setup menu.
- ▲/▼/◀/▶ : Selects an item in a menu.
- ENTER** : Enters the selection in memory.

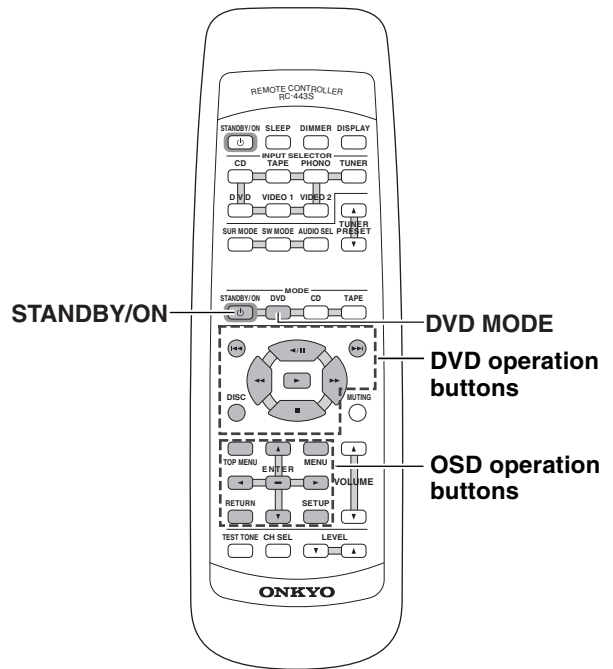

# Pre-programming remote controller (North American models only)

Pre-programming code is only available on the RC-444M remote controller for TX-DS494 North American model.

## Learning a pre-programming code

You can make RC-444M remote controller to operate a product from other brand than Onkyo by storing the pre-programming code of the brand in the RC-444M.

1. Find the 2-digit number for the brand name of the component that you want to operate in the table on page 33.
2. Turn on the component that you want to operate (i.e. DVD, satellite tuner, or television).
3. While holding down the MODE button on the RC-444M that you want to program, press the LEVEL ▲ button, and then release both buttons.
4. Within 30 seconds, enter the 2-digit code number.

To enable entry of the 2-digit code number, some of the remote controller keys become the numeric keys with the assignment as shown in the figure.

5. Press some operation buttons for the component that you want to operate to check if the system operates properly.

If the system operates properly, the code is correct. If the component does not operate properly, return to step 3.

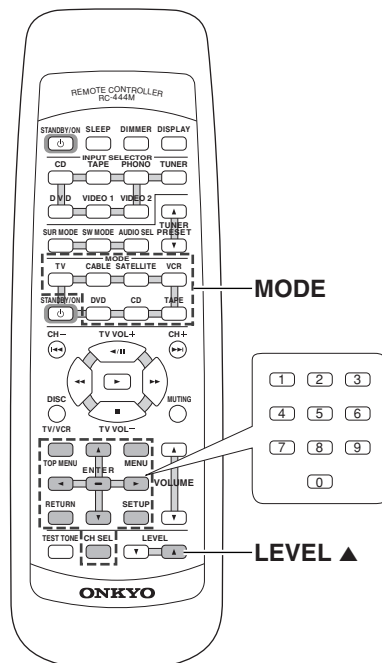

### Notes:

- With some brand's components, some buttons may not work correctly.
- If more than one code is given in the table, try the code one by one until you reach the code for your component (i.e. if the first code does not work, then try the next).

## Controlling a DVD player

Buttons with programmed usage and operations are the same as the operational buttons on page 31.

### When entering the code of Onkyo DVD players

There are three SETTING numbers. Choose the SETTING number according to how you will be using the DVD player.

**No. 02/03:** These codes are for operating the Onkyo DVD player by pointing the remote controller directly at it, either because it does not have an **RI** connector, or it does but you are not using an **RI** cable and connecting it. First enter 02 and if it does not operate properly, enter 03.

**No. 01:** This code is for Onkyo DVD players that have an **RI** connector that you are connecting to the TX-DS494 with an **RI** cable. You will then operate the DVD player by pointing the remote controller at the remote control sensor on the TX-DS494. You do not need to enter this code because it is factory preset. However, if the code has been changed to 02 or 03, then you will need to change it back to 01.

## Controlling a TV/VCR/Cable TV/Satellite tuner

1. Press the desired MODE button.
2. Press the STANDBY/ON button to turn on the device.
3. Press the desired operation button.

### TV mode

- CH+ : Changes the TV channel upward.
- CH- : Changes the TV channel downward.
- TV VOL+ : Increases the TV volume.
- TV VOL- : Decrease the TV volume.
- TV/VCR : Switches the TV/VCR inputs.

### VCR mode

- CH+ : Changes the received channel upward.
- CH- : Changes the received channel downward.
- ▶ : Starts playback of videotape.
- : Stops playback, recording, fast forward or rewinding.
- ▶▶ : Fast-forwards the videotape.
- ◀◀ : Rewinds the videotape.
- ◀|| : Lets playback pause temporarily.

### CABLE/SAT mode

- CH+ : Changes the received channel upward.
- CH- : Changes the received channel downward.



## Pre-programming remote controller (North American models only)

### CODE LIST

Brand	TV	VCR	CABLE	DVD	SAT
ADMIRAL	01-03	01	—	—	—
AIWA	—	02	—	—	—
AOC	04	—	—	—	—
AUDIO DYNAMIC	—	03, 04	—	—	—
BELL & HOWELL	01, 02	05	—	—	—
BROKSONIC	04	06, 07	—	—	—
CANON	—	08, 09	—	—	—
CITIZEN	—	10	—	—	—
CRAIG	05-08	10	—	—	—
CROSLEX	09	—	—	—	—
CURTIS MATHIS	04, 08, 10	02, 09, 11	—	—	—
DAEWOO	04, 11, 12	09, 12, 13	—	—	—
DAYTRON	13	—	—	—	—
DBX	—	03, 04, 14	—	—	—
DENON	—	—	—	04, 05	—
DIMENSIA	—	11	—	—	—
EHOSTAR	—	—	—	—	01
EMERSON	04-08, 13, 14	06, 07, 13, 15-17	—	—	—
FISHER	15	05, 18-20	—	—	—
FUNAI	—	02	—	—	—
GE	03, 04, 16-18	09, 11, 21	—	—	—
GENERAL INSTRUMENT	—	—	06-13	—	02
GOLDSTAR	04, 13, 19	10	—	—	—
HAMLIN	—	—	01-05	—	—
HITACHI	04, 13, 20, 21	08, 11, 22	—	—	07
INSTANT REPLAY	—	08, 09	—	—	—
JC PENNEY	03, 04, 17, 19	03-05, 09, 11, 22	—	—	—
JERROLD	—	—	06-13	—	02
JVC	22	03, 04	—	06	01
KENWOOD	—	03, 04, 10	—	—	—
KTV	04, 08, 13	—	—	—	—
LXI	03, 09, 10, 15	02, 05, 10, 18-20, 22	—	—	—
MAGNAVOX	04, 09, 13	08, 09, 23	—	—	08
MARANTZ	—	03, 04	—	—	—
MARTA	—	10	—	—	—
MEMOREX	—	09, 20	—	—	—
MINOLTA	—	11, 22	—	—	—
MITSUBISHI	04, 23	24-27	—	—	—
MULTITECH	—	02, 26, 28	—	—	—
NEC	04	03, 04	—	—	03, 04
OAK	—	—	14-16	—	—
OLYMPIC	—	08, 09	—	—	—
ONKYO	—	—	—	01-03	—
PANASONIC	16-18, 24	08, 09, 29	17-19	05, 07	09
PENTAX	—	11, 22	—	—	—
PHILCO	04, 09, 13	08, 09	—	—	—
PHILIPS	09	08, 09, 23	—	—	—
PIONEER	10, 18, 25	08	20, 21	08-10	—
PORTLAND	04, 26	—	—	—	—
PRIMESTAR	—	—	—	—	02
PROSCAN	03	08, 09, 11, 12, 22, 23, 30, 31	—	—	—
QUASAR	17, 18	08, 09	—	—	—
RADIO SHACK	03, 04, 08, 23	—	—	—	10
RCA	03, 04, 17, 26-28	08, 09, 11, 12, 22, 23, 30, 31	—	11	05
REALISTIC	—	02, 05, 09, 20, 25, 32	—	—	—
SAMSUNG	04, 13, 29	28, 31, 33	—	12	—
SANSUI	—	03	—	—	—
SANYO	15	05, 20	—	—	—
SCIENTIFIC ATLANTA	—	—	22-24	—	—
SCOTT	04, 08	12, 20, 24-28, 31	—	—	—
SHARP	02, 13, 14	01, 32	—	—	—
SIGNATURE 2000	01, 02	01, 02	—	—	—
SONY	30	34-36	—	13	06
SYLVANIA	04, 09	02, 08, 09, 23	—	—	—
SYMPHONIC	08	02	—	—	—
TASHIRO	—	10	—	—	—
TATUNG	—	03, 04	—	—	—
TEAC	—	02-04	—	—	—
TECHNICS	—	08, 09	—	—	—
TOCOM	—	—	25	—	—
TOSHIBA	02, 10	12, 30	—	14	11
UNIDEN	—	—	—	—	08
VIDTECH	04, 20	—	—	—	—
WARDS	04, 13, 14	01, 10, 20, 32, 37	—	—	—
YAMAHA	02, 23	03-05, 24	—	05, 15	—
ZENITH	01, 31	37	26, 27	—	12

# Troubleshooting guide

---

If a problem occurs while you are using the remote controller, first try to operate the controls on the front panel of the TX-DS494 to make sure that it is not due to a malfunction (or worn out batteries) in the remote controller.

## POWER

### No power.

- Power cord is disconnected.  
→ Connect power cord (page 20).
- There is external noise in the computer circuits of this unit.  
→ Remove the AC plug from the outlet and then plug it again (page 20).
- AC fuse blown.  
→ Contact your Onkyo Service Center.

### Power on but no sound.

- MUTING indicator flashes.  
→ Press the MUTING button on the remote controller to turn it off (page 23).
- Bad connections.  
→ Check connections, speaker leads, etc (pages 10-17).
- Amplifier protection circuitry has been activated. (“PROTECT” will be displayed.)  
→ Contact your Onkyo Service Center.
- Input selector is not set properly.  
→ Set to correct input source (page 22).
- Headphones are connected.  
→ Lower volume and then disconnect headphones (page 8).

## SPEAKERS

### No sound from the center speaker, or very minimal sound.

- Speaker cable is not corrected.  
→ Check the connection between the TX-DS494 and the speaker (page 17).
- Listening mode is set to STEREO or ORCHESTRA.  
→ If listening mode is set to STEREO or ORCHESTRA, the center speaker outputs only the effect sound (pages 26-28).
- Speaker configuration is set to 2 ch or 4 ch.  
→ Set the speaker configuration to the 3 ch or 5 ch (page 21).

### No sound or very low volume from subwoofer.

- Subwoofer mode is set to “OFF”.  
→ Check the subwoofer mode setting (page 21).
- Subwoofer mode setting is improper.  
→ Check the subwoofer mode setting (page 21).

### Hum, low-frequency noise.

- Poor or no input ground.  
→ Check outer conductor of input plugs (pages 10-15).
- Poor or no phono motor ground.  
→ Check for proper ground connection (page 13).
- The placement of the audio connection cables on the rear panel is incorrect.  
→ Adjust the placement of the cable to reduce hum.

### Howling when the volume is turned up.

- Turntable and speakers are too close together.  
→ Move them farther apart.

### Rough or scratchy sound. High range is not clear.

- Stylus of turntable pick-up is worn.  
→ Replace.
- Turntable stylus tip is dirty.  
→ Clean.
- Treble control too high.  
→ Turn treble control down (page 8).

## VIDEO and AUDIO

### Desired picture does not appear.

- Improper connection.  
→ Check the connection again. Insert the plugs and connectors completely (pages 10-15).

### Picture and sound do not match.

- Improper connection.  
→ Check connections (pages 10-15).

### No picture appears on the TV screen (or monitor).

- TV (or monitor) is not set to receive the output signals from the receiver.  
→ Set the TV (or monitor) to the receiver input.
- Video cable is not connected securely.  
→ Check connections (pages 10-15).

# Troubleshooting guide

## FM/AM TUNER

### AM stations cannot be received.

- AM loop antenna is not attached.
  - Connect the included AM loop antenna to the AM antenna terminals (page 18).

### Buzzing noise on AM (particularly conspicuous at night or with weak stations).

- Noise from electrical apparatus such as fluorescent lamp.
  - Move the AM loop antenna to different position (page 18).
  - Set up an outdoor AM antenna (page 19).

### High-pitched noise or buzzing noise on AM.

- Noise from TV set.
  - Place the AM loop antenna as far as possible from the TV.
  - Move unit away from TV set.

### Crackling noise on AM, FM.

- Noise caused by turning fluorescent lamp on and off.
  - Move antenna as far as possible from the fluorescent lamp.
- Noise from automobile ignition.
  - Install an FM outdoor antenna as far as possible from the road (page 19).
  - Change the position or direction of the outdoor antenna.

### TUNED and STEREO indicators light on but sound is distorted and stereo separation is bad.

- Station is too strong.
  - Change to FM indoor antenna (page 18).
- Multiple reflection of the radio waves because of tall buildings or mountains.
  - Use antenna which has better directivity and select a point where the distortion is least (page 19).

### TUNED and STEREO indicators flicker and hiss is heard on FM.

- Station is too weak.
  - Install an outdoor FM antenna (page 19).
- Stereo FM broadcasts cover only about half the distance of an ordinary broadcast.
  - Change the position or direction of the outdoor antenna.

### No station is recalled.

- The power cord has been unplugged or the POWER switch has been turned off for a long time.
  - The memory contents are lost. Store all stations again (page 25).

## REMOTE CONTROLLER

### Front panel controls function but remote controller does not.

- No batteries in remote controller.
  - Insert batteries (page 5).
- Batteries have worn out.
  - Replace batteries (page 5).
- Remote controller is not pointed at the remote sensor of the TX-DS494.
  - Point the remote controller at the remote sensor of the TX-DS494 (page 5).
- Remote controller is too far from the TX-DS494.
  - Operate the remote controller within 5 meters (16 feet) (page 5).

### RC-444M remote controller does not operate Onkyo DVD player properly (North American models only).

- Pre-programming code is improper.
  - Change the pre-program code (page 32).

## OTHER

### LATE NIGHT function cannot be used.

- Playback source is not Dolby Digital encoded.
  - Check that the  DIGITAL indicator lights up in the display (pages 8, 28).

### Multichannel audio is not output.

- Input signal format is set to AUTO or ANALOG.
  - Check that the component is connected to the MULTI CHANNEL INPUT port and check the input signal format setting (pages 11, 23).

Also refer to the respective instruction manuals of the compact disc player, DVD player, video cassette recorder, TV monitor, etc., that compose your entertainment system.

The TX-DS494 contains an internal microcomputer that performs high-level operations. However, on extremely rare occasions, noise or interference from an external source or static electricity may cause faulty operation. If this occurs, unplug the power cord from the wall outlet, wait five or more seconds, and then plug it back in. This should correct the situation.

\*To reset the surround mode and other settings to the factory default settings, hold down the VIDEO 1 button with the TX-DS494 turned on and then press the SPEAKERS A button. "CLEAR" appears in the front display and the TX-DS494 enters the standby state.

# Specifications

## AMPLIFIER SECTION

Continuous Average Power output (FTC)	
All channels:	<b>55 watts per channel min. RMS at 8 ohms, 2 channels driven from 20 Hz to 20 kHz with no more than 0.08% total harmonic distortion.</b>
	<b>70 watts min. RMS at 6 ohms, 2 channels driven from 1 kHz with no more than 0.1% total harmonic distortion.</b>
Continuous Power output (DIN)	75 watts × 5 at 6 ohms
Maximum Power output (EIAJ)	100 watts × 5 at 6 ohms
Total Harmonic Distortion:	0.08% at rated power (Front)
IM Distortion:	0.08% at rated power (Front)
Damping Factor:	60 at 8 ohms (Front)
Input Sensitivity and Impedance	
PHONO:	2.5 mV, 50 kohms
LINE (CD, TAPE, DVD, VIDEO 1, 2):	200 mV, 50 kohms
MULTICHANNEL INPUT	
(FRONT L/R, SURROUND L/R, CENTER):	200 mV, 50 kohms
(SUBWOOFER):	36 mV, 50 kohms
DIGITAL 2 (COAXIAL):	0.5 Vp-p, 75 ohms
Output Level and Impedance	
Rec out (TAPE, VIDEO 2):	200 mV, 2.2 kohms
Pre out (SUBWOOFER):	1 V, 2.2 kohms
Phono Overload:	110 mV RMS at 1 kHz, 0.5% T.H.D.
Frequency Response:	20 Hz to 100 kHz, +1/-3 dB
RIAA Deviation:	20 Hz to 20 kHz, ±0.8 dB
Tone Control	
Bass:	±10 dB at 50 Hz
Treble:	±10 dB at 10 kHz
Signal-to-Noise Ratio	
Phono:	80 dB (IHF-A, 5 mV input)
CD/Tape:	100 dB (IHF-A)

## VIDEO SECTION

Input Sensitivity and Impedance	
VIDEO (DVD, VIDEO 1, 2):	1 Vp-p, 75 ohms
S VIDEO (DVD, VIDEO 1, 2):	1 Vp-p, 75 ohms (Y)
	0.28 Vp-p, 75 ohms (C)
Output Level and Impedance	
VIDEO (VIDEO 2, MONITOR):	1 Vp-p, 75 ohms
S VIDEO (MONITOR):	1 Vp-p, 75 ohms (Y)
	0.28 Vp-p, 75 ohms (C)

## TUNER SECTION

FM	
Tuning Range:	87.5-108.0 MHz (50 kHz steps)
Usable Sensitivity	
Mono:	11.2 dBf, 1.0 μV (75 ohms)
Stereo:	17.2 dBf, 2.0 μV (75 ohms)
50 dB Quieting Sensitivity	
Mono:	17.2 dBf, 2.0 μV (75 ohms)
Stereo:	37.2 dBf, 2.0 μV (75 ohms)

Capture Ratio:	2.0 dB
Image Rejection Ratio	
North American models:	40 dB
Other models:	85 dB
IF Rejection Ratio:	90 dB
Signal-to-Noise Ratio	
Mono:	76 dB
Stereo:	70 dB
Alternate Channel Attenuation:	55 dB
Selectivity:	50 dB (DIN)
AM Suppression Ratio:	50 dB
Total Harmonic Distortion	
Mono:	0.2%
Stereo:	0.3%
Frequency Response:	30 Hz-15 kHz, ±1.0 dB
Stereo Separation:	45 dB at 1 kHz
	30 dB at 100 Hz-10 kHz

## AM

Tuning Range	
North American models:	530-1,710 kHz (10 kHz steps)
European & Australian models:	522-1,611 kHz (9 kHz steps)
Worldwide models:	531-1,602 kHz (9 kHz steps), 530-1,710 kHz (10 kHz steps)
Usable Sensitivity:	30 μV
Image Rejection Ratio:	40 dB
IF Rejection Ratio:	40 dB
Signal-to-Noise Ratio:	40 dB
Total Harmonic Distortion:	0.7%

## GENERAL

Power Supply:	AC 120 V, 60 Hz AC 230-240 V, 50 Hz AC 220-230 V and 120 V switchable, 50/60 Hz
Power Consumption:	3.4 A 260 W
Dimensions (W × H × D):	435 × 150 × 339 mm 17-1/8" × 5-7/8" × 13-3/8"
Weight	
North American models:	9.7 kg, 21.4 lbs.
European & Australian models:	10.3 kg, 22.7 lbs.
Worldwide models:	10.9 kg, 24.0 lbs.

## REMOTE CONTROL

Transmitter:	Infrared
Signal range:	Approx. 5 meters, 16 ft.
Power supply:	Two "AA" batteries (1.5 V × 2)

Specifications and features are subject to change without notice.  
Power supply and voltage vary depending on the area in which the unit is purchased.

## ONKYO CORPORATION

Sales & Product Planning Div. : 2-1, Nisshin-cho, Neyagawa-shi, OSAKA 572-8540, JAPAN  
Tel: 072-831-8111 Fax: 072-833-5222 <http://www.onkyo-intl.com>

### ONKYO U.S.A. CORPORATION

18 Park Way, Upper Saddle River, N.J. 07458, U.S.A.  
Tel: 201-785-2600 Fax: 201-785-2650 <http://www.onkyousa.com>

### ONKYO EUROPE ELECTRONICS GmbH

Liegnitzerstrasse 6, 82194 Groebenzell, GERMANY  
Tel: +49-8142-4401-0 Fax: +49-8142-4401-555 <http://www.onkyo.net>

### ONKYO CHINA LIMITED

Units 2102-2107, Metroplaza Tower I, 223 Hing Fong Road, Kwai Chung,  
N.T., HONG KONG Tel: 852-2429-3118 Fax: 852-2428-9039 <http://www.onkyochina.com>

